



Competition Sheet

체급별 대진 정보

QUALIFICATIONS				1/4 FINALS				SEMIFINALS				FINAL							
1	SHARIFZODA A	TJK		1	0/4	TJK	P1/P2 4/0	2	5/8	JPN	P1/P2 2/6								
2	HASEGAWA K	JPN	P1/P2 3/8	2	5/4	JPN	P1/P2 4/0												
3	TIAN Q	CHN	P1/P2 0/0																
4	ALYAMANI BAM	YEM	P1/P2 0/0																
5	ZHOLCHUBEKOV K	KGZ	P1/P2 6/4	5	0/0	KGZ	P1/P2 0/0												
6	KIM Y	KOR	P1/P2 12/0																
7	PUNTSAG E	MGL	P1/P2 4/0	6	3/1	KOR	P1/P2 1/0												
8	KEBISPAYEV A	KAZ	P1/P2 1/0																
9	RAVINDER S	IND	P1/P2 0/0	8	4/8	KAZ	P1/P2 8/0												
10	AL SAEDI MAS	IRQ	P1/P2 5/4																
11	ARRAR IYH	JOR	P1/P2 0/0	10	0/0	IRQ	P1/P2 0/0												
12	MAHMUDOV A	UZB	P1/P2 8/0																
13	ANGANA MJ	PHI	P1/P2 6/0	12	0/0	UZB	P1/P2 0/0												
14	YUN W	PRK	P1/P2 8/0																
15	WANA T	MYA	P1/P2 0/0	14	3/7	PRK	P1/P2 7/0												
REPECHAGE																			
UPPER BRANCH				3	5/3	CHN	P1/P2 1/2	3	3/4	CHN	P1/P2 4/0	BRONZE				3	TIAN Q	CHN	
LOWER BRANCH				1	0/0	TJK	P1/P2 0/0	6	0/0	KOR	P1/P2 0/0	BRONZE				8	KEBISPAYEV A	KAZ	
				15	0/0	MYA	P1/P2 0/0	12	0/9	UZB	P1/P2 9/0					8	5/8	KAZ	P1/P2 4/4
				12	4/8	UZB	P1/P2 8/0												

GOLD

2 HASEGAWA K JPN

CLASSIFICATION

1	HASEGAWA K	JPN
2	YUN W	PRK
3	TIAN Q	CHN
3	KEBISPAYEV A	KAZ
5	KIM Y	KOR
5	MAHMUDOV A	UZB
7	ZHOLCHUBEKOV K	KGZ
8	AL SAEDI MAS	IRQ
9	PUNTSAG E	MGL
10	ANGANA MJ	PHI
11	SHARIFZODA A	TJK
12	RAVINDER S	IND
13	ARRAR IYH	JOR
14	ALYAMANI BAM	YEM
15	WANA T	MYA



Competition Sheet

체급별 대진 정보

QUALIFICATIONS				1/4 FINALS				SEMIFINALS				FINAL			
1	AL SAEEDI AJJ	IRQ		1	0	P1	P2	2	1	P1	P2	4	0	P1	P2
				0	0	0	0	1	1	1	0	0	0	0	0
2	RI H	PRK		2	3	P1	P2	4	3	P1	P2	11	3	P1	P2
				6	6	2	4	4	4	4	0	2	2	0	2
3	0	TUN A	MYA	4	3	P1	P2	7	1	P1	P2				
	0			5	5	2	3	6	6	0	6				
4	4	MATSUMOTO R	JPN	6	1	P1	P2	7	3	P1	P2				
	10			2	2	2	0	3	3	3	0				
5	0	YADAV ST	IND	10	0	P1	P2	7	1	P1	P2				
	0			0	0	0	0	6	6	0	6				
6	4	OBLOBERDIEV K	TJK	11	3	P1	P2	11	3	P1	P2				
	10			0	0	0	0	6	6	0	6				
7	4	TASMURADOV E	UZB	11	0	P1	P2	11	3	P1	P2				
	11			0	0	0	0	3	3	3	1				
8	0	SALAH EAAA	YEM	13	0	P1	P2	13	3	P1	P2				
	0			0	0	0	0	0	0	0	6				
9	0	ORASHEV A	TKM	13	0	P1	P2	13	0	P1	P2				
	0			0	0	0	0	0	0	0	0				
10	4	ZHANBIROV A	KAZ	13	0	P1	P2	13	0	P1	P2				
	9			0	0	0	0	0	0	0	0				
11	5	RYU H	KOR	13	0	P1	P2	13	0	P1	P2				
	4			0	0	0	0	0	0	0	0				
12	0	ZHENG P	CHN	13	0	P1	P2	13	0	P1	P2				
	0			0	0	0	0	0	0	0	0				
13	4	BYABANGARD A	IRI	13	0	P1	P2	13	0	P1	P2				
	8			0	0	0	0	0	0	0	0				
14	0	TSAREV R	KGZ	13	0	P1	P2	13	0	P1	P2				
	0			0	0	0	0	0	0	0	0				

GOLD		
11	RYU H	KOR

CLASSIFICATION		
1	RYU H	KOR
2	MATSUMOTO R	JPN
3	RI H	PRK
3	BYABANGARD A	IRI
5	OBLOBERDIEV K	TJK
5	TASMURADOV E	UZB
7	ZHANBIROV A	KAZ
8	ZHENG P	CHN
9	AL SAEEDI AJJ	IRQ
10	TSAREV R	KGZ
11	ORASHEV A	TKM
12	YADAV ST	IND
13	SALAH EAAA	YEM
14	TUN A	MYA

REPECHAGE

UPPER BRANCH				LOWER BRANCH			
3	0	MYA	P1 P2	6	0	TJK	P1 P2
	0		0 0	0	0		0 0
6	4	TJK	P1 P2	2	3	PRK	P1 P2
	8		8 0	4	4		4 0
12	1	CHN	P1 P2	13	3	IRI	P1 P2
	3		2 1	4	7		4 3
13	3	IRI	P1 P2	7	1	UZB	P1 P2
	5		5 0	1	1		1 0



Competition Sheet

체급별 대진 정보

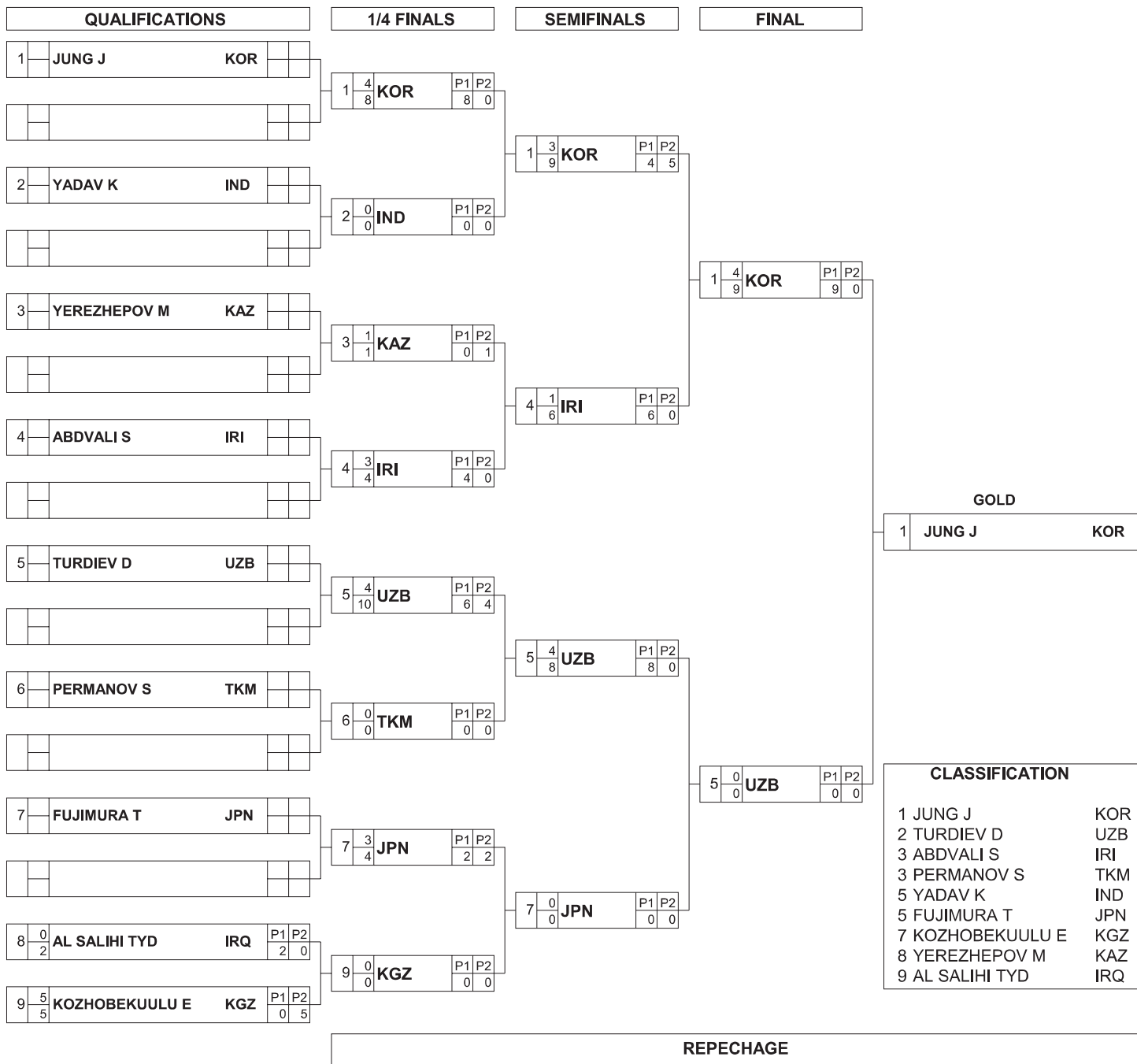

CLASSIFICATION	
1	JUNG J KOR
2	TURDIEV D UZB
3	ABDVALI S IRI
3	PERMANOV S TKM
5	YADAV K IND
5	FUJIMURA T JPN
7	KOZHOBKUULU E KGZ
8	YEREZHEPOV M KAZ
9	AL SALIHI TYD IRQ



Competition Sheet

체급별 대진 정보

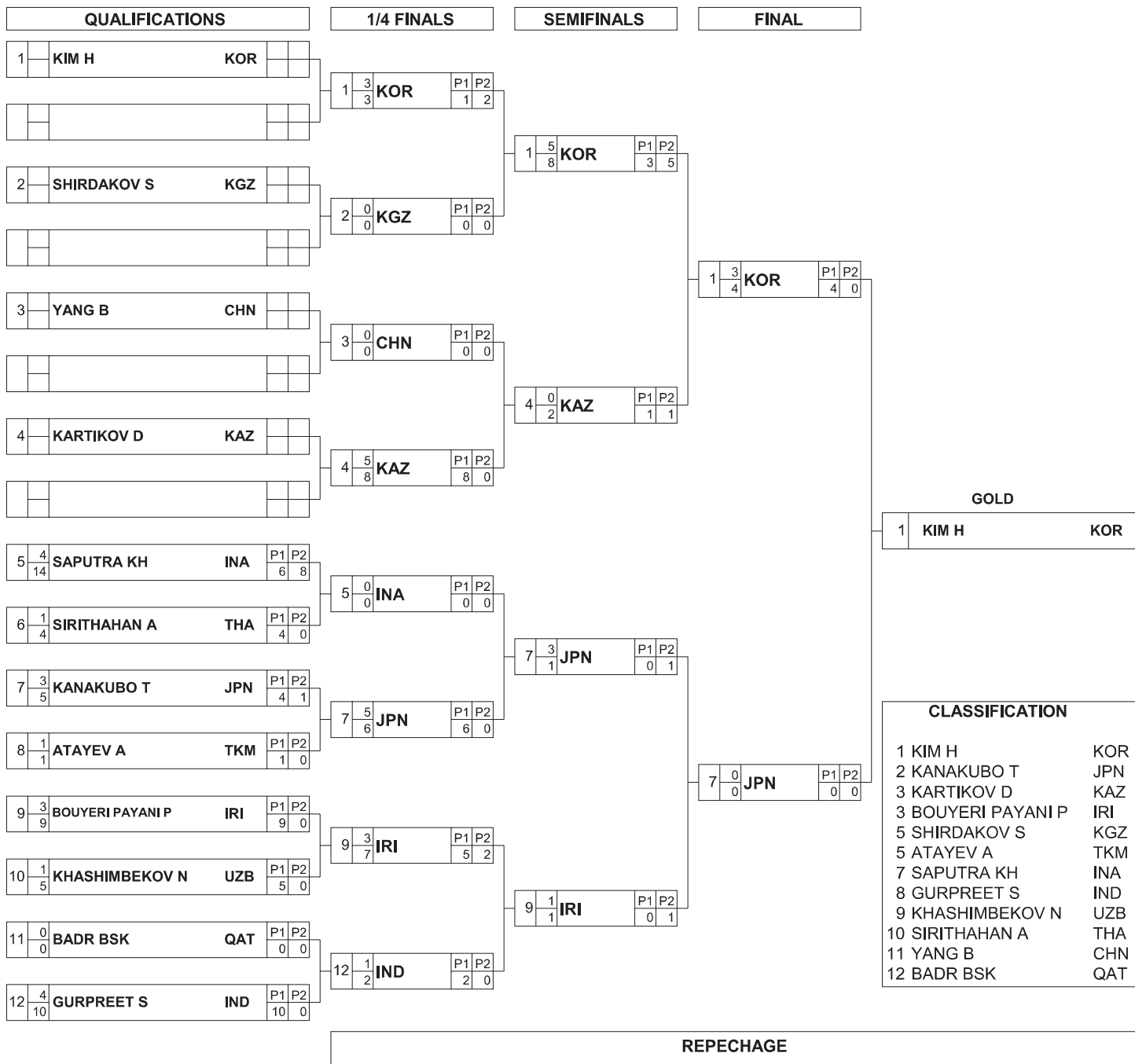

UPPER BRANCH

LOWER BRANCH

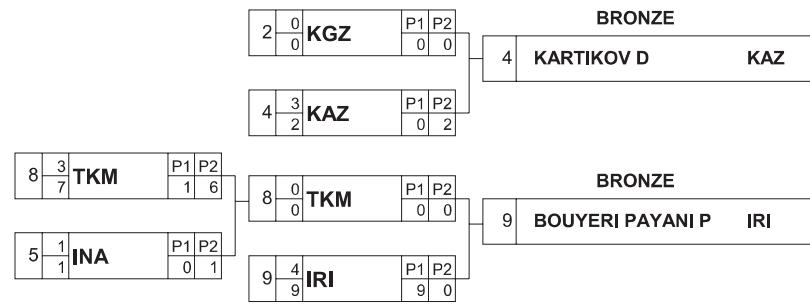



Competition Sheet

체급별 대진 정보

1/4 FINALS				SEMIFINALS				FINAL					
1	$\frac{1}{2}$	HARPREET S	IND	P1	P2	2	0	0	0				
2	$\frac{3}{4}$	SALDADZE B	UZB	P1	P2	4	3	5	2	3			
3	$\frac{1}{1}$	KHAN JKM	QAT	P1	P2	4	4	9	4	5			
4	$\frac{4}{9}$	AKHLAGHI H	IRI	P1	P2	6	3	4	2	2			
5	$\frac{0}{0}$	ALQUHALI MHMG	YEM	P1	P2	6	1	1	1	0			
6	$\frac{5}{5}$	TSURUMAKI T	JPN	P1	P2	7	1	2	4	0			
7	$\frac{5}{4}$	KENJEEV J	KGZ	P1	P2	7	5	4	4	0			
8	$\frac{0}{0}$	CHEN W	CHN	P1	P2								

REPECHAGE			
UPPER BRANCH			
3	$\frac{0}{0}$	QAT	P1 P2 0 0
2	$\frac{4}{8}$	UZB	P1 P2 8 0
LOWER BRANCH			
5	$\frac{0}{0}$	YEM	P1 P2 0 0
7	$\frac{5}{4}$	KGZ	P1 P2 4 0

GOLD			
4		AKHLAGHI H	IRI

CLASSIFICATION			
1		AKHLAGHI H	IRI
2		TSURUMAKI T	JPN
3		SALDADZE B	UZB
3		KENJEEV J	KGZ
5		KHAN JKM	QAT
5		ALQUHALI MHMG	YEM
7		HARPREET S	IND
8		CHEN W	CHN



Competition Sheet

체급별 대진 정보

QUALIFICATIONS				1/4 FINALS				SEMIFINALS				FINAL			
1	MANOJ K	IND		1	IND	P1 P2		2	CHN	P1 P2					
2	PENG F	CHN		2	CHN	P1 P2									
3	ASSAKALOV R	UZB	P1 P2	3	UZB	P1 P2						3	UZB	P1 P2	
			4 0				5 1								8 0
4	Khonekeo	LAO	P1 P2					3	UZB	P1 P2					
			0 0												
5	TURSYNOV N	KAZ	P1 P2	5	KAZ	P1 P2									
			10 0				0 0								
6	KANCHALEE C	THA	P1 P2												
			0 0												
7	KARIMFAR M	IRI	P1 P2	7	IRI	P1 P2									
			8 0				4 1								
8	SHAHIN AMI	JOR	P1 P2					10	KOR	P1 P2					
			0 0												
9	OKA T	JPN	P1 P2	10	KOR	P1 P2									
			0 0				5 3								
10	LEE S	KOR	P1 P2												
			0 5												
11	BEISHEBEKOV A	KGZ	P1 P2	11	KGZ	P1 P2						10	KOR	P1 P2	
			3 1				11 0								0 0
12	ESENOV K	TKM	P1 P2												
			0 0												
13	HANINI IS M	PLE	P1 P2	14	PHI	P1 P2									
			0 0				1 2								
14	BALABAL J	PHI	P1 P2												
			10 0				2 0								

REPECHAGE										
4	LAO	P1 P2		5	KAZ	P1 P2		BRONZE		
			0 0				1 2	2	PENG F	CHN
				2	CHN	P1 P2		BRONZE		
							3 3	7	KARIMFAR M	IRI
				9	JPN	P1 P2				
							0 0			
				7	IRI	P1 P2				
							3 2			
				11	KGZ	P1 P2				
							0 0			

CLASSIFICATION			
1	ASSAKALOV R	UZB	
2	LEE S	KOR	
3	PENG F	CHN	
3	KARIMFAR M	IRI	
5	TURSYNOV N	KAZ	
5	BEISHEBEKOV A	KGZ	
7	BALABAL J	PHI	
8	ESENOV K	TKM	
8	MANOJ K	IND	
10	OKA T	JPN	
11	SHAHIN AMI	JOR	
12	HANINI IS M	PLE	
12	KANCHALEE C	THA	
14	Khonekeo	LAO	

GOLD			
3	ASSAKALOV R	UZB	

UPPER BRANCH			

LOWER BRANCH			

Timing and Results provided by Tissot



Competition Sheet

체급별 대진 정보

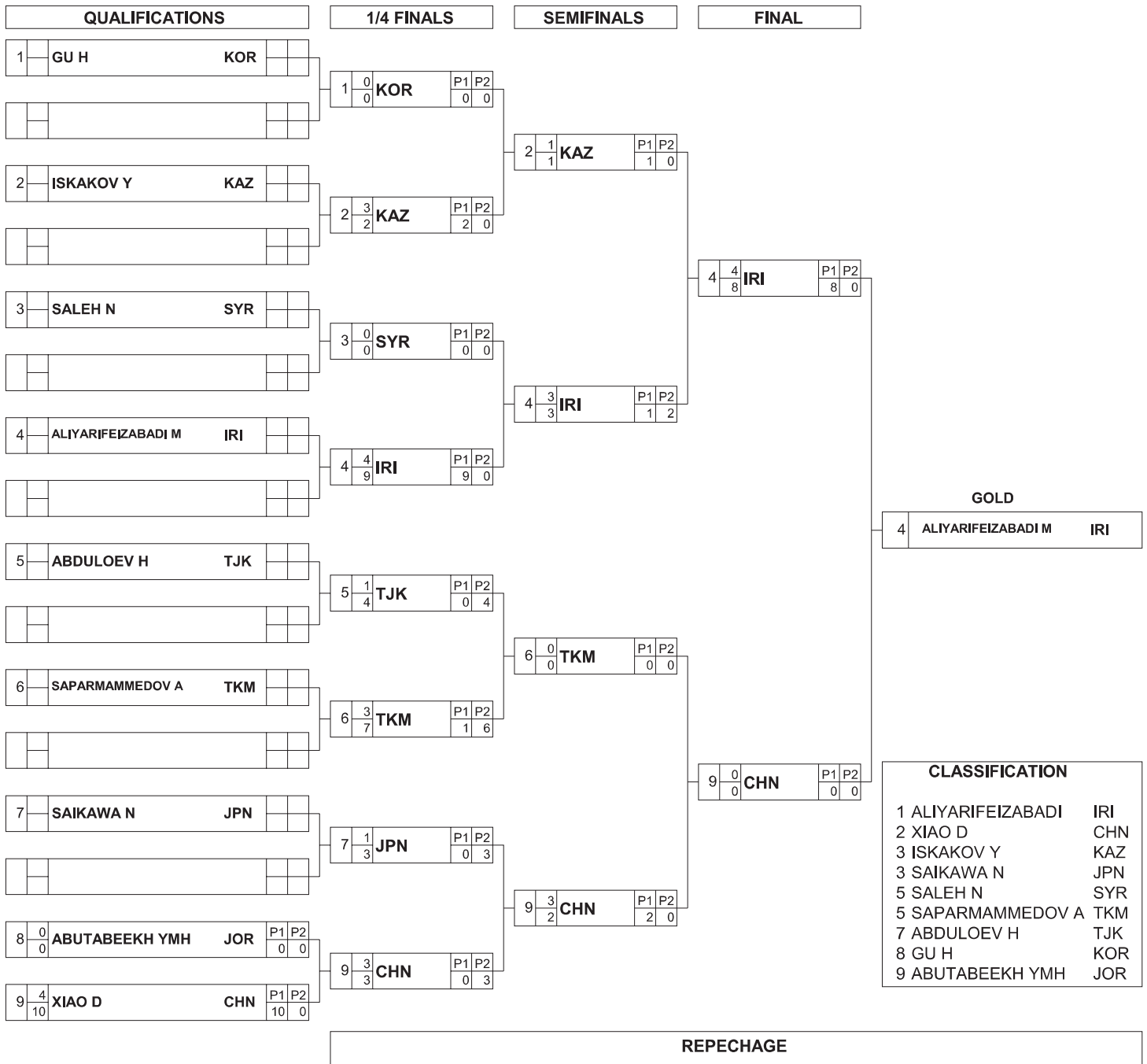



Competition Sheet

체급별 대진 정보

QUALIFICATIONS	1/4 FINALS	SEMIFINALS	FINAL
1 KIM Y KOR	1 3/3 KOR P1 P2 2 1	1 3/3 KOR P1 P2 0 3	1 0/0 KOR P1 P2 0 0
2 MARAFI HSAR JOR	2 0/0 JOR P1 P2 0 0	3 1/1 CHN P1 P2 0 1	8 TINALIYEV N KAZ
3 MENG Q CHN	3 4/8 CHN P1 P2 8 0	6 1/1 KGZ P1 P2 1 0	GOLD 8 TINALIYEV N KAZ
4 ALGHADHRI ANS IRQ	4 0/0 IRQ P1 P2 0 0	8 3/5 KAZ P1 P2 4 1	
5 TUYCHIEV M TJK	5 0/0 TJK P1 P2 0 0	8 3/5 KAZ P1 P2 3 2	CLASSIFICATION 1 TINALIYEV N KAZ 2 KIM Y KOR 3 MENG Q CHN 3 BABAJANZADEH DAR IRI 5 MARAFI HSAR JOR 5 RAMONOV M KGZ 7 MAMASOLIEV A UZB 8 TUYCHIEV M TJK 9 ALGHADHRI ANS IRQ 9 DALAL D IND
6 RAMONOV M KGZ	6 3/1 KGZ P1 P2 1 0	10 0/0 IRI P1 P2 0 0	
7 MAMASOLIEV A UZB P1 P2 2 0	8 3/1 KAZ P1 P2 0 1	REPECHAGE	
8 TINALIYEV N KAZ P1 P2 7 4	10 3/5 IRI P1 P2 2 3		
9 DALAL D IND P1 P2 0 0	6 1/1 KGZ P1 P2 0 1	UPPER BRANCH 2 1/2 JOR P1 P2 2 0 3 3/7 CHN P1 P2 6 1 3 MENG Q CHN	
10 BABAJANZADEH DARZ. IRI P1 P2 8 0	7 0/0 UZB P1 P2 0 0	LOWER BRANCH 7 0/0 UZB P1 P2 0 0 10 3/4 IRI P1 P2 4 0 10 3/5 IRI P1 P2 2 3 6 1/1 KGZ P1 P2 0 1 10 BABAJANZADEH DARZ. IRI	



Competition Sheet

체급별 대진 정보

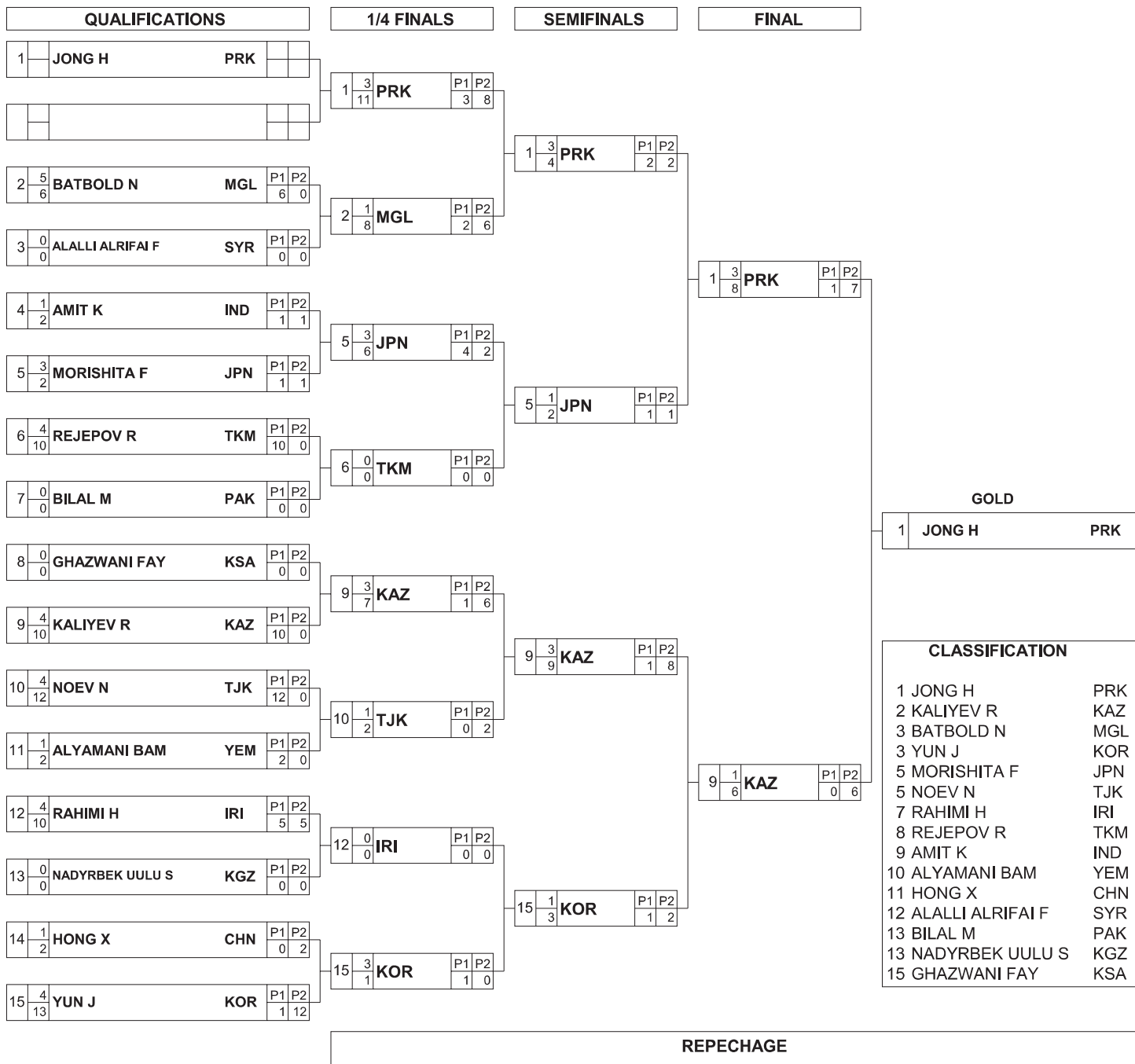

REPECHAGE

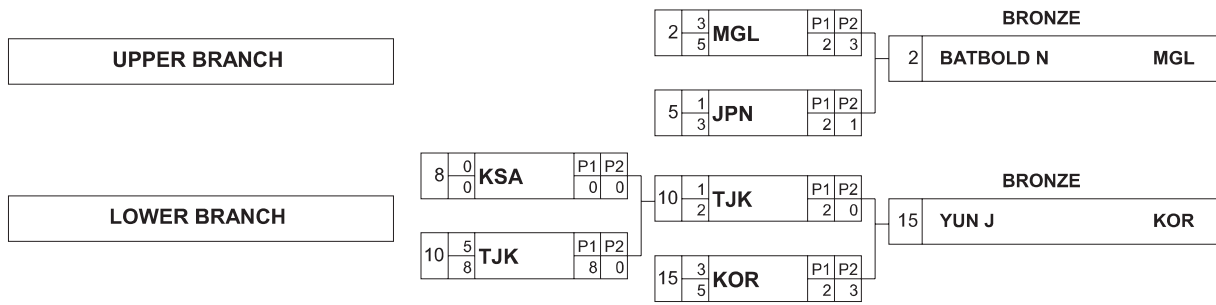



Competition Sheet

체급별 대진 정보

QUALIFICATIONS				1/4 FINALS				SEMIFINALS				FINAL			
1	NADYRBEK UULU U	KGZ		1	0	0	P1 P2	3	1	3	P1 P2	7	3	6	P1 P2
2	BORJAKOV B	TKM	P1 P2 1 0	3	3	3	P1 P2 1 2	7	3	8	P1 P2 1 7				
3	NIYAZBEKOV D	KAZ	P1 P2 4 5	5	1	2	P1 P2 0 2								
4	GOWDOOEI HAR	QAT	P1 P2 1 1	7	3	7	P1 P2 1 6								
5	LEE S	KOR	P1 P2 8 4	9	0	0	P1 P2 0 0	11	1	2	P1 P2 2 0				
6	KENJAEV J	UZB	P1 P2 1 0	11	3	3	P1 P2 3 0	15	1	4	P1 P2 0 4				
7	ESMAELPOORJOUYBA.	IRI	P1 P2 4 7	12	1	7	P1 P2 6 1								
8	ABDULHADI ZAM	KSA	P1 P2 1 0	15	3	2	P1 P2 0 2								
9	NGUON M	CAM	P1 P2 12 0	15	4	17	P1 P2 3 14								
10	HWANG R	PRK	P1 P2 0 1												
11	TAKATSUKA N	JPN	P1 P2 1 2												
12	USMONZODA F	TJK	P1 P2 10 0												
13	SALAH EAAA	YEM	P1 P2 0 0												
14	TUMENBILEG T	MGL	P1 P2 4 1												
15	Bajrang	IND	P1 P2 2 3												

REPECHAGE										
6	1	7	P1 P2 2 5	5	4	12	P1 P2 12 0	5	LEE S	KOR
5	3	9	P1 P2 9 0	3	1	1	P1 P2 1 0			
14	3	8	P1 P2 4 4	14	1	2	P1 P2 1 1	11	TAKATSUKA N	JPN
12	0	0	P1 P2 0 0	11	3	2	P1 P2 1 1			

UPPER BRANCH		LOWER BRANCH	

GOLD	
7	ESMAELPOORJOUYBA. IRI

CLASSIFICATION	
1	ESMAELPOORJOUYB IRI
2	Bajrang IND
3	LEE S KOR
3	TAKATSUKA N JPN
5	NIYAZBEKOV D KAZ
5	TUMENBILEG T MGL
7	USMONZODA F TJK
8	NGUON M CAM
9	KENJAEV J UZB
10	GOWDOOEI HAR QAT
11	HWANG R PRK
12	BORJAKOV B TKM
13	ABDULHADI ZAM KSA
14	NADYRBEK UULU U KGZ
15	SALAH EAAA YEM



Competition Sheet

체급별 대진 정보

QUALIFICATIONS	1/4 FINALS	SEMIFINALS	FINAL
1 ZHUMAGAZYEV D KAZ	1 0/6 KAZ P1 P2 6 0	2 0/7 CHN P1 P2 3 4	<p style="text-align: center;">GOLD</p> <p>3 DUTT Y IND</p> <p style="text-align: center;">CLASSIFICATION</p> <p>1 DUTT Y IND 2 YUSUPOV Z TJK 3 YEERLANBIEKE K CHN 3 NAVRUZOV I UZB 5 KANG J PRK 5 ISHIDA T JPN 7 BATCHULUUN B MGL 8 MAMATOV U KGZ 9 ZHUMAGAZYEV D KAZ 10 IBRAHIM AIA QAT 10 LAZKANI MUNLA BA SYR 10 WEERASINGHEGE CMSRI</p>
2 YEERLANBIEKE K CHN	2 5/4 CHN P1 P2 0 4	3 5/9 IND P1 P2 1 8	
3 DUTT Y IND	3 3/7 IND P1 P2 2 5	3 3/1 IND P1 P2 1 0	
4 KANG J PRK	4 1/4 PRK P1 P2 2 2	8 1/5 JPN P1 P2 2 3	
5 4/10 BATCHULUUN B MGL P1 P2 10 0	5 1/2 MGL P1 P2 2 0	9 0/0 TJK P1 P2 0 0	
6 0/0 WEERASINGHEGE CMP SRI P1 P2 0 0	8 3/2 JPN P1 P2 0 2	9 3/10 TJK P1 P2 8 2	
7 0/0 LAZKANI MUNLA BAD. SYR P1 P2 0 0	9 3/10 TJK P1 P2 8 2	9 3/5 TJK P1 P2 1 4	
8 4/10 ISHIDA T JPN P1 P2 2 8	11 1/8 UZB P1 P2 2 6		
9 3/4 YUSUPOV Z TJK P1 P2 0 4			
10 1/3 MAMATOV U KGZ P1 P2 1 2			
11 4/10 NAVRUZOV I UZB P1 P2 6 4			
12 0/0 IBRAHIM AIA QAT P1 P2 0 0			
REPECHAGE			

UPPER BRANCH

LOWER BRANCH

UPPER BRANCH	LOWER BRANCH
4 1/6 PRK P1 P2 6 0	10 0/0 KGZ P1 P2 0 0
2 YEERLANBIEKE K CHN	11 4/10 UZB P1 P2 2 8
2 3/11 CHN P1 P2 2 9	11 3/5 UZB P1 P2 1 4
	8 1/5 JPN P1 P2 1 4
	11 NAVRUZOV I UZB



Competition Sheet

체급별 대진 정보

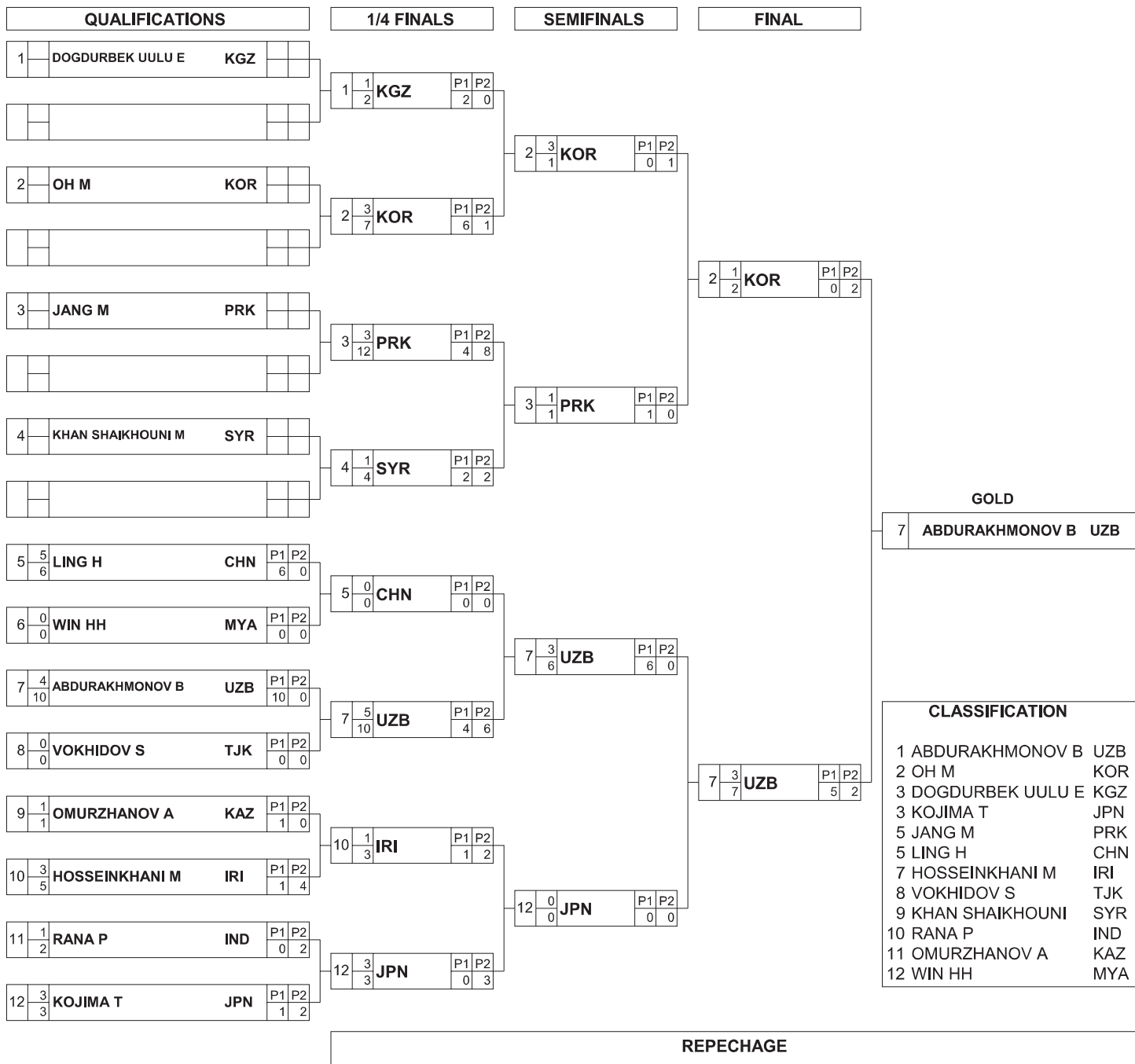

CLASSIFICATION

1	ABDURAKHMONOV B	UZB
2	OH M	KOR
3	DOGDURBEK UULU E	KGZ
3	KOJIMA T	JPN
5	JANG M	PRK
5	LING H	CHN
7	HOSSEINKHANI M	IRI
8	VOKHIDOV S	TJK
9	KHAN SHAIKHOUNI	SYR
10	RANA P	IND
11	OMURZHANOV A	KAZ
12	WIN HH	MYA

REPECHAGE

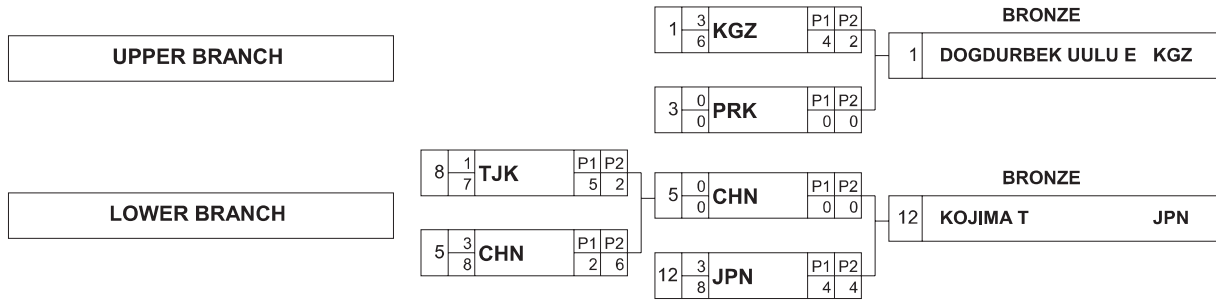



Competition Sheet

체급별 대진 정보

QUALIFICATIONS	1/4 FINALS	SEMIFINALS	FINAL
1 AKBARIZARINKOLAEI IRI	1 4/10 IRI P1 P2 10 0	1 3/4 IRI P1 P2 3 1	1 1/2 IRI P1 P2 0 2
2 BUTT MA PAK	2 0/0 PAK P1 P2 0 0	3 1/3 KOR P1 P2 0 3	11 KURBANOV R UZB
3 3/7 LEE S KOR P1 P2 6 1	3 3/10 KOR P1 P2 6 4	10 1/3 JPN P1 P2 2 1	CLASSIFICATION 1 KURBANOV R UZB 2 AKBARIZARINKOLAEI IRI 3 LEE S KOR 3 YADAV NP IND 5 BUTT MA PAK 5 SHIMADA D JPN 7 ZHANG C CHN 8 KAMBAROV R TKM 9 SUFIEV A TJK 10 INNOKENTEVI I KGZ 11 DORJVAANCHIG G MGL 12 ALQUHALI MHMG YEM 12 RAUT BL NEP 12 ZAW MYINT T MYA
4 1/3 DORJVAANCHIG G MGL P1 P2 0 3	5 1/6 CHN P1 P2 6 0	11 3/5 UZB P1 P2 2 3	
5 4/10 ZHANG C CHN P1 P2 6 4	8 0/0 TJK P1 P2 0 0	11 4/10 UZB P1 P2 10 0	
6 0/0 RAUT BL NEP P1 P2 0 0	10 4/10 JPN P1 P2 1 9	10 3/4 JPN P1 P2 3 1	
7 0/0 ZAW MYINT T MYA P1 P2 0 0	11 1/2 IND P1 P2 2 0	13 0/0 TKM P1 P2 0 0	
8 4/10 SUFIEV A TJK P1 P2 10 0	12 4/11 IND P1 P2 11 0		
9 1/3 INNOKENTEVI I KGZ P1 P2 0 3	13 1/1 TKM P1 P2 1 0		
10 3/4 SHIMADA D JPN P1 P2 3 1			
11 3/3 KURBANOV R UZB P1 P2 0 3			
12 1/2 YADAV NP IND P1 P2 2 0			
13 4/10 KAMBAROV R TKM P1 P2 6 4			
14 0/0 ALQUHALI MHMG YEM P1 P2 0 0			

REPECHAGE

UPPER BRANCH

LOWER BRANCH

UPPER BRANCH	LOWER BRANCH
2 1/2 PAK P1 P2 2 0	12 3/10 IND P1 P2 1 9
3 3/6 KOR P1 P2 4 2	10 1/7 JPN P1 P2 2 5
3 LEE S KOR	12 YADAV NP IND



Competition Sheet

체급별 대진 정보

1/8 FINALS				1/4 FINALS				SEMIFINALS				FINAL					
1	5/5	NURZHUMBAYEV Y	KAZ	P1	P2	1	4	1	4	1	4	1	4				
2	0/8	ISMANOV U	UZB	P1	P2	2	2	2	6								
3	0/3	PHACHANXAY P	LAO	P1	P2	3	3	3	0								
4	5/12	INAM M	PAK	P1	P2	4	12	4	0								
5	1/4	Fahriansyah	INA	P1	P2	5	3	5	1								
6	3/6	MELEJAYEV Y	TKM	P1	P2	6	2	6	4								
7	4/12	KADIROV B	TJK	P1	P2	7	12	7	0								
8	0/0	ALAA N H ABUSNAIN.	PLE	P1	P2	8	0	8	0								
9	1/1	ZHANG F	CHN	P1	P2	9	0	9	1								
10	4/11	MOSTAFAJOUKAR M	IRI	P1	P2	10	4	10	7								
11	4/10	KUMAR P	IND	P1	P2	11	10	11	0								
12	0/0	SUMIR KS	NEP	P1	P2	12	0	12	0								
13	0/0	TEPAKAM M	THA	P1	P2	13	0	13	0								
14	4/11	PUREVEE U	MGL	P1	P2	14	11	14	0								
15	3/9	KIM G	KOR	P1	P2	15	5	15	4								
16	0/0	MATSUMOTO S	JPN	P1	P2	16	0	16	0								

1/4 FINALS				SEMIFINALS				FINAL										
1	4/16	KAZ	P1	P2	1	10	1	6	1	4	1	4	1	4				
4	1/5	PAK	P1	P2	4	4	4	1										
6	1/2	TKM	P1	P2	6	0	6	2										
7	1/4	TJK	P1	P2	7	3	7	1										
7	3/6	TJK	P1	P2	7	2	7	4										
10	4/10	IRI	P1	P2	10	6	10	4										
10	3/4	IRI	P1	P2	10	0	10	4										
11	0/0	IND	P1	P2	11	0	11	0										
14	1/6	MGL	P1	P2	14	6	14	0										
15	1/1	KOR	P1	P2	15	1	15	0										
15	3/10	KOR	P1	P2	15	4	15	6										

SEMIFINALS				FINAL														
1	4/14	KAZ	P1	P2	1	2	1	12	1	1	1	4	1	4				
7	1/4	TJK	P1	P2	7	3	7	1										
10	1/4	KAZ	P1	P2	10	2	10	2										
10	4/14	IRI	P1	P2	10	3	10	11										

FINAL																		
10	1/4	KAZ	P1	P2	10	2	10	2										
10	4/14	IRI	P1	P2	10	3	10	11										

REPECHAGE																		
2	4/10	UZB	P1	P2	2	8	2	2										
4	0/0	PAK	P1	P2	4	0	4	0										
7	1/1	TJK	P1	P2	7	0	7	1										
9	3/4	CHN	P1	P2	9	2	9	2										
11	1/1	IND	P1	P2	11	0	11	1										
15	4/10	KOR	P1	P2	15	8	15	2										

UPPER BRANCH				LOWER BRANCH														
2	4/12	UZB	P1	P2	2	5	2	7										
7	1/1	TJK	P1	P2	7	0	7	1										
2	2	ISMANOV U	UZB															
9	0/0	CHN	P1	P2	9	0	9	0										
15	4/10	KOR	P1	P2	15	8	15	2										
2	2	ISMANOV U	UZB															
15	15	KIM G	KOR															

GOLD																		
10	10	MOSTAFAJOUKAR M	IRI															

CLASSIFICATION			
1	MOSTAFAJOUKAR M	IRI	
2	NURZHUMBAYEV Y	KAZ	
3	ISMANOV U	UZB	
3	KIM G	KOR	
5	KADIROV B	TJK	
5	ZHANG F	CHN	
7	INAM M	PAK	
8	PUREVEE U	MGL	
9	KUMAR P	IND	
10	MELEJAYEV Y	TKM	
11	Fahriansyah	INA	
12	PHACHANXAY P	LAO	
13	MATSUMOTO S	JPN	
14	SUMIR KS	NEP	
15	TEPAKAM M	THA	
16	ALAA N H ABUSNAI	PLE	



Competition Sheet

체급별 대진 정보

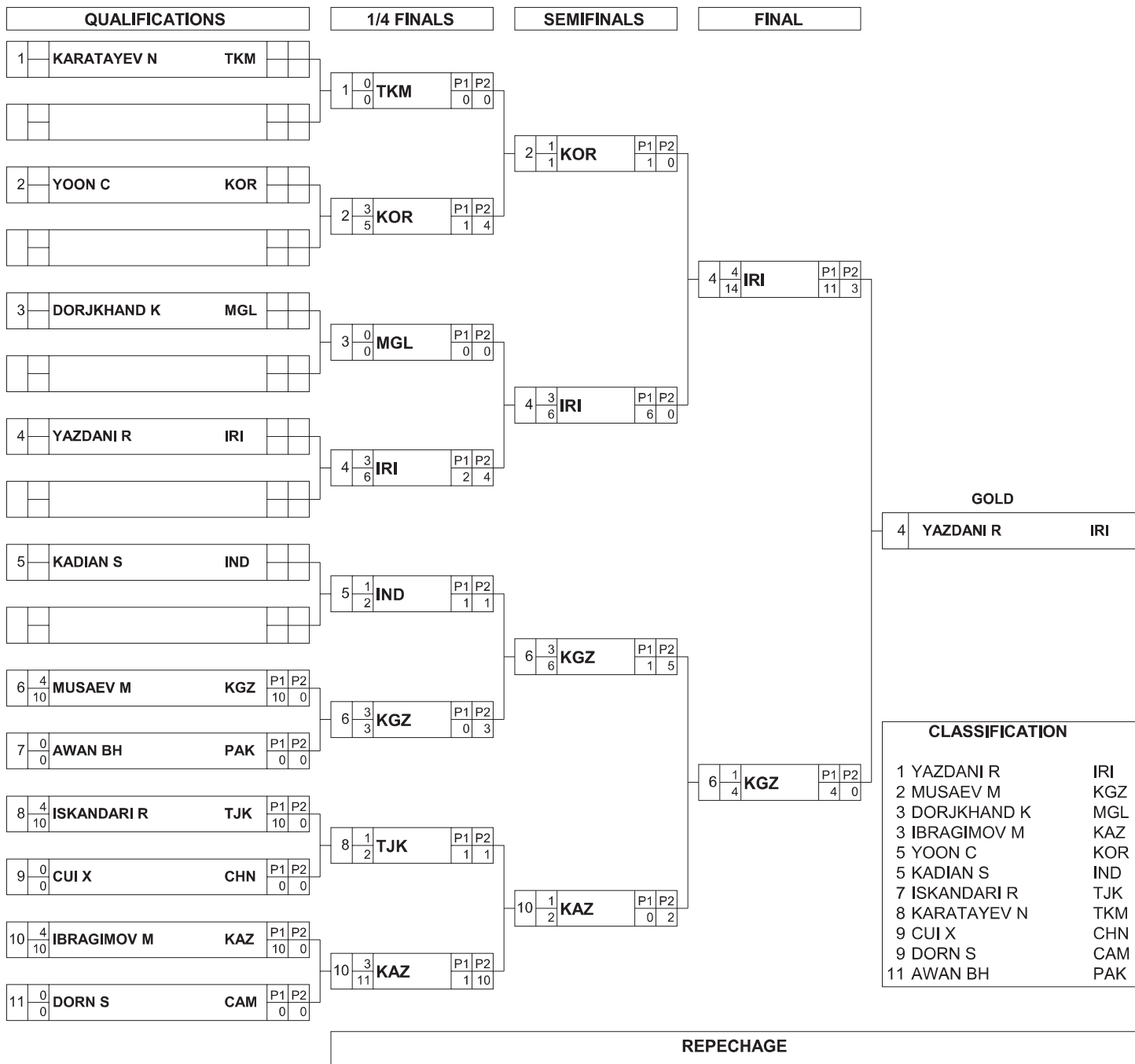



Competition Sheet

체급별 대진 정보

QUALIFICATIONS	1/4 FINALS	SEMIFINALS	FINAL
1 AL KRAD R SYR	1 0/0 SYR P1 P2 0 0	2 3/3 KAZ P1 P2 2 1	2 1/1 KAZ P1 P2 0 1
2 SHABANBAY D KAZ	2 3/7 KAZ P1 P2 6 1	4 0/0 JPN P1 P2 0 0	9 3/6 IRI P1 P2 5 1
3 SAKLAWÉ MSA IRQ	3 0/4 IRQ P1 P2 4 0	5 1/1 KOR P1 P2 0 1	9 3/6 IRI P1 P2 5 1
4 ARAKIDA N JPN	4 5/11 JPN P1 P2 11 0	9 3/9 IRI P1 P2 4 5	
5 NAM K KOR	5 3/3 KOR P1 P2 1 2		
6 LAZAREV A KGZ	6 0/0 KGZ P1 P2 0 0		
7 5/4 JARGALSAIKHAN C MGL P1 P2 4 0	7 0/0 MGL P1 P2 0 0		
8 0/0 SALEM SMS KSA P1 P2 0 0			
9 4/11 HADI BASMANJ P IRI P1 P2 4 7	9 3/4 IRI P1 P2 3 1		
10 0/0 DENG Z CHN P1 P2 0 0			
GOLD			
9 HADI BASMANJ P IRI			
CLASSIFICATION			
1 HADI BASMANJ P IRI			
2 SHABANBAY D KAZ			
3 ARAKIDA N JPN			
3 NAM K KOR			
5 AL KRAD R SYR			
5 JARGALSAIKHAN C MGL			
7 DENG Z CHN			
8 SAKLAWÉ MSA IRQ			
9 LAZAREV A KGZ			
10 SALEM SMS KSA			
REPECHAGE			
UPPER BRANCH			
1 1/2 SYR P1 P2 2 0			
4 ARAKIDA N JPN			
4 3/11 JPN P1 P2 6 5			
LOWER BRANCH			
10 1/10 CHN P1 P2 9 1			
7 1/6 MGL P1 P2 4 2			
5 3/14 KOR P1 P2 5 9			
5 NAM K KOR			



Competition Sheet

체급별 대진 정보

QUALIFICATIONS	1/4 FINALS	SEMIFINALS	FINAL
1 MUANGPOR M THA	1 3/12 THA P1 P2 6 6	1 0/0 THA P1 P2 0 0	<p style="text-align: center;">GOLD</p> <p>12 TOSAKA E JPN</p>
2 CHOVS CAM	2 1/5 CAM P1 P2 4 1	4 4/10 CHN P1 P2 10 0	
3 FILIPPOVA M TKM	3 1/2 TKM P1 P2 2 0	4 1/4 IND P1 P2 2 2	
4 3/8 SUN Y CHN P1 P2 2 6	4 4/12 CHN P1 P2 12 0	12 3/5 JPN P1 P2 2 3	
5 1/3 AMANZHOL T KAZ P1 P2 1 2	6 0/0 UZB P1 P2 0 0	12 3/5 JPN P1 P2 2 3	
6 5/11 YAKHSHIMURATOVA D UZB P1 P2 4 7	8 5/10 IND P1 P2 6 4	12 3/5 JPN P1 P2 2 3	
7 0/0 KYU KT MYA P1 P2 0 0	11 0/0 MGL P1 P2 0 0	12 3/5 JPN P1 P2 2 3	
8 3/4 Vinesh IND P1 P2 0 4	12 4/10 JPN P1 P2 8 2	12 3/5 JPN P1 P2 2 3	
9 1/3 PAK Y PRK P1 P2 1 2	12 3/5 JPN P1 P2 2 4	12 3/5 JPN P1 P2 2 3	
10 1/1 NGUYEN TL VIE P1 P2 0 1	12 3/5 JPN P1 P2 2 4	12 3/5 JPN P1 P2 2 3	
11 3/3 ERDENESUKH N MGL P1 P2 1 2	12 3/5 JPN P1 P2 2 4	12 3/5 JPN P1 P2 2 3	
12 3/6 TOSAKA E JPN P1 P2 2 4	12 3/5 JPN P1 P2 2 4	12 3/5 JPN P1 P2 2 3	
13 1/2 LEE Y KOR P1 P2 0 2	12 3/5 JPN P1 P2 2 4	12 3/5 JPN P1 P2 2 3	

CLASSIFICATION

1 TOSAKA E	JPN
2 SUN Y	CHN
3 AMANZHOL T	KAZ
3 Vinesh	IND
5 MUANGPOR M	THA
5 ERDENESUKH N	MGL
7 YAKHSHIMURATOVA	UZB
8 LEE Y	KOR
9 CHOVS	CAM
10 PAK Y	PRK
11 FILIPPOVA M	TKM
12 NGUYEN TL	VIE
13 KYU KT	MYA

REPECHAGE

UPPER BRANCH	LOWER BRANCH
5 4/10 KAZ P1 P2 10 0	11 3/6 MGL P1 P2 3 3
3 0/0 TKM P1 P2 0 0	8 4/10 IND P1 P2 10 0
1 0/0 THA P1 P2 0 0	11 0/0 MGL P1 P2 0 0
5 4/10 KAZ P1 P2 10 0	8 4/10 IND P1 P2 10 0
5 AMANZHOL T KAZ	8 Vinesh IND

Timing and Results provided by Tissot



Competition Sheet

체급별 대진 정보

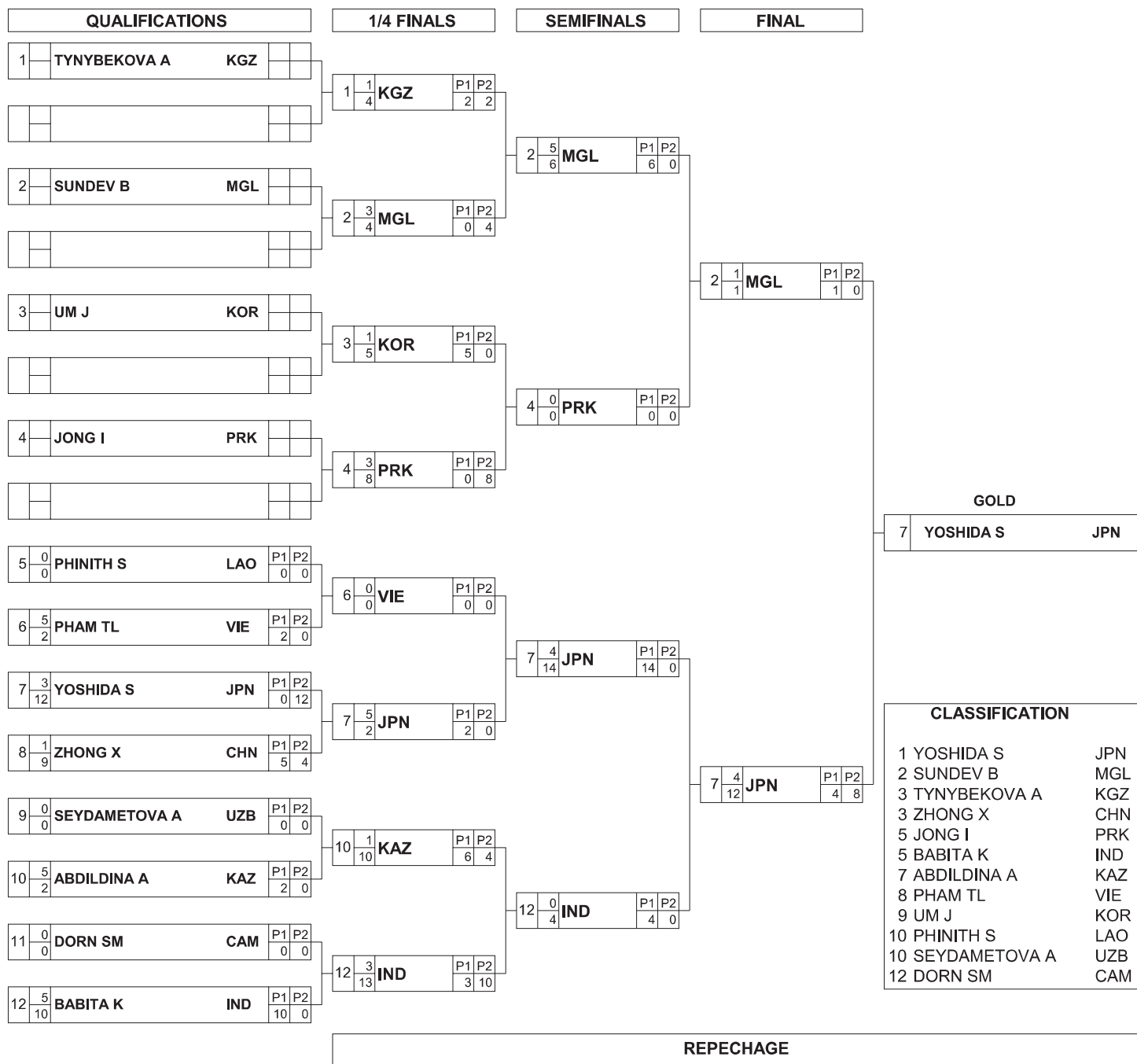

Timing and Results provided by Tissot



Competition Sheet

체급별 대진 정보

QUALIFICATIONS				1/4 FINALS				SEMIFINALS				FINAL				
1	SUKHEE T	MGL		1	5/2	MGL	P1/P2 2/0	1	1/8	MGL	P1/P2 6/2					
2	KIM R	PRK		2	0/2	PRK	P1/P2 2/0									
3	0/0	LATXOMPHOU O	LAO	P1/P2 0/0	4	0/2	KOR	P1/P2 2/0					5	3/4	JPN	P1/P2 2/2
4	4/10	KIM K	KOR	P1/P2 10/0					5	3/11	JPN	P1/P2 7/4				
5	4/10	WATARI R	JPN	P1/P2 10/0	5	5/12	JPN	P1/P2 6/6								
6	0/0	CHEN WL	TPE	P1/P2 0/0												
7	5/6	XILUO Z	CHN	P1/P2 6/0	7	5/4	CHN	P1/P2 4/0								
8	0/0	SULTAMURATOVA A	UZB	P1/P2 0/0					7	5/11	CHN	P1/P2 6/5				
9	0/0	MAY TP	MYA	P1/P2 0/0	10	0/0	VIE	P1/P2 0/0								
10	4/10	LY TH	VIE	P1/P2 10/0												
11	3/5	JAKHAR G	IND	P1/P2 0/5	11	5/8	IND	P1/P2 8/0								
12	1/4	LARIONOVA Y	KAZ	P1/P2 2/2					11	0/2	IND	P1/P2 2/0				
13	4/10	AUTNUN J	THA	P1/P2 10/0	13	0/0	THA	P1/P2 0/0								
14	0/0	SHUMILOVA V	TKM	P1/P2 0/0												

REPECHAGE			
UPPER BRANCH			
6	1/2	TPE	P1/P2 2/0
4	3/7	KOR	P1/P2 5/2
4	0/0	KOR	P1/P2 0/0
1	4/10	MGL	P1/P2 10/0
1		SUKHEE T	MGL
LOWER BRANCH			
8	0/0	UZB	P1/P2 0/0
10	5/8	VIE	P1/P2 8/0
10	0/0	VIE	P1/P2 0/0
11	5/4	IND	P1/P2 4/0
11		JAKHAR G	IND

CLASSIFICATION			
1	WATARI R	JPN	
2	XILUO Z	CHN	
3	SUKHEE T	MGL	
3	JAKHAR G	IND	
5	KIM K	KOR	
5	LY TH	VIE	
7	AUTNUN J	THA	
8	LARIONOVA Y	KAZ	
9	CHEN WL	TPE	
10	KIM R	PRK	
11	LATXOMPHOU O	LAO	
11	MAY TP	MYA	
11	SHUMILOVA V	TKM	
14	SULTAMURATOVA A	UZB	



Competition Sheet

체급별 대진 정보

QUALIFICATIONS				SEMIFINALS				FINAL								
1	YU T	TPE		1	1 2	TPE	P1 0	P2 2	2	0 0	KAZ	P1 0	P2 0			
2	5 7	MANYUROVA G	KAZ	P1 1	P2 6	2	4 12	KAZ	P1 8	P2 4	5	3 3	CHN	P1 1	P2 2	
3	0 0	HWANG E	KOR	P1 0	P2 0	5	3 2	ZHOU F	CHN	P1 1	P2 1	5	4 11	CHN	P1 5	P2 6
4	1 1	HAMAGUCHI K	JPN	P1 0	P2 1	6	0 0	Jyoti	IND	P1 0	P2 0	7	1 2	MGL	P1 0	P2 2
5	3 2	ZHOU F	CHN	P1 1	P2 1	7	4 10	OCHIRBAT B	MGL	P1 8	P2 2	CLASSIFICATION 1 ZHOU F CHN 2 MANYUROVA G KAZ 3 HWANG E KOR 3 OCHIRBAT B MGL 5 YU T TPE 5 HAMAGUCHI K JPN 7 Jyoti IND				
6	0 0	Jyoti	IND	P1 0	P2 0	REPECHAGE										
7	4 10	OCHIRBAT B	MGL	P1 8	P2 2	3	3 4	KOR	P1 1	P2 3	BRONZE 3 HWANG E KOR					
UPPER BRANCH				LOWER BRANCH				BRONZE 7 OCHIRBAT B MGL								
								BRONZE 7 OCHIRBAT B MGL								