



## Liste des Engagés par pays / Entry-List By Country

### Hungarian Greco-Roman Golden GP

STYLE GR



#### BELARUS (BLR)

**Lutteur(s) / Wrestler(s) :**

130 kg	HRYSHCHANKA, Kiryl
59 kg	DAUROV, Soslan TAZHIEV, Elbek
66 kg	LIAKH, Pavel
75 kg	BACHKO, Yauhen
85 kg	KIKINIOU, Aliaksandr
98 kg	DZEINICHENKA, Tsimafei STARADUB, Siarhei

#### CROATIA (CRO)

**Lutteur(s) / Wrestler(s) :**

59 kg	LIZATOVIC, Ivan
66 kg	ETLINGER, Dominik JANECIC, Danijel
75 kg	STARCEVIC, Bozo
85 kg	ZUGAJ, Nenad

#### CZECH REPUBLIC (CZE)

**Lutteur(s) / Wrestler(s) :**

66 kg	MORBITZER, Matous
75 kg	NOVAK, Petr

#### DENMARK (DEN)

**Lutteur(s) / Wrestler(s) :**

59 kg	FONNESBEK, Tobias
66 kg	BJERREHUUS, Fredrik EKSTROEM, Anders
75 kg	ISKANDARANI, Ahmed MADSEN, Mark

#### EGYPT (EGY)

**Lutteur(s) / Wrestler(s) :**

59 kg	HAITHEM MAHMOUD, Ahmed Fahmy HASSAN ABDELAAL MOHAMED, Mostafa
-------	--



## Liste des Engagés par pays / Entry-List By Country

### Hungarian Greco-Roman Golden GP

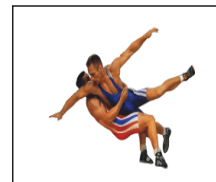

#### STYLE GR

66 kg	IBRAHIM MAHMOUD, Hamed Hassan
80 kg	TAREK MOHAMED, Abdelsalam Shibl
85 kg	AHMED MOHAMED, Ibrahim Othman
98 kg	ABDELLATIF MOHAMED, Ahmed Abdellatif

#### ESTONIA (EST)

##### Lutteur(s) / Wrestler(s) :

130 kg	NABI, Heiki
--------	-------------

#### GEORGIA (GEO)

##### Lutteur(s) / Wrestler(s) :

130 kg	GOGISVANIDZE, Shota KAJAIA, Iakob
59 kg	DAVITADZE, Goderzi VANADZE, Miorza
66 kg	LASHKHI, Revaz
71 kg	JAVAKHIA, Giorgi MAMAGEISHVILI, Anton TSULUKIDZE, Mindia
75 kg	GULBATASHVILI, Ilia KELASOV, Nikoloz TSKHADAIA, Manuchar
80 kg	TSIREKIDZE, Giorgi
85 kg	GEGESHIDZE, Vladimer SOPADZE, Mate
98 kg	IMERLISHVILI, Vasil JABIDZE, Soso

#### HUNGARY (HUN)

##### Lutteur(s) / Wrestler(s) :

130 kg	LAM, Balint LIGETI, Daniel
59 kg	KNIPLI, Csongor KOVACS, Bence MODOS, Peter
66 kg	FRITSCH, Robert JAGER, Krisztian KOZAK, Istvan LOSONCZI, Otto SZAKOLCI, Zoltan TOTH, Mark YAMAMOTO, Asen



## Liste des Engagés par pays / Entry-List By Country

### Hungarian Greco-Roman Golden GP

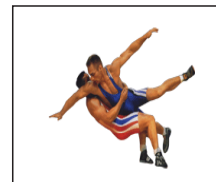

#### STYLE GR

71 kg	KORPASI, Balint KOTTES, Pal LEVAI, Zoltan
75 kg	MADARASI, Gabor NAGY, Peter SZABO, Martin SZABO, Laszlo
80 kg	BACSI, Peter DR. KUN, R. Zsolt SZILVASSY, Erik UBRANKOVICS, Norbert
85 kg	BALOGH, Laszlo SZABO, Patrik
98 kg	ALMASI, Ferenc FODOR, Peter FODOR, Tamas KISS, Balazs MAJOROS, Armin Mozes MERTSE, Adam NEMETH, Ivan TOROK, Zsolt VARGA, Adam

#### IRAN R.I. (IRI)

##### Lutteur(s) / Wrestler(s) :

66 kg	GERAEI, Mohammadali
71 kg	TAHERISARTAND, Ramin
75 kg	BOUYERI PAYANI, Payam
80 kg	ZINATIREFAH, Ali
85 kg	KARIMFAR, Mojtaba

#### ITALY (ITA)

##### Lutteur(s) / Wrestler(s) :

75 kg	RUSSO, Ciro
85 kg	PARISI, Fabio
98 kg	TIMONCINI, Daigoro

#### JAPAN (JPN)

##### Lutteur(s) / Wrestler(s) :

130 kg	SONODA, Arata
59 kg	FUMITA, Kenichiro OTA, Shinobu



## Liste des Engagés par pays / Entry-List By Country

### Hungarian Greco-Roman Golden GP



#### STYLE GR

66 kg	HORIGO, Yuta INOUE, Tomohiro MATSUMOTO, Ryutaro
75 kg	KANAKUBO, Takehiro SAKABE, Soh YABIKU, Shohei
80 kg	MAETA, Yuya SUMI, Masato
85 kg	OKA, Taichi
98 kg	OSAKA, Akira

#### KAZAKHSTAN (KAZ)

##### Lutteur(s) / Wrestler(s) :

130 kg	KUZEMBAYEV, Damir SARTBAYEV, Abdumalik TINALIYEV, Nurmakhan
59 kg	AINAGULOV, Mirambek DONENBEKOV, Meirbek KEBISPAYEV, Almat NUGUMANOV, Aidyn SARSENBIYEV, Zhanserik USKENBEKOV, Dastan ZHAKANSNA, Khorlan
66 kg	KAIRATOV, Yeldar KARIPZHAN, Abylai NURGALIYEV, Nurtai NURSAPA, Bakbergen YENSEKHANOV, Aibek ZHADRAYEV, Demeu ZHANBIROV, Ashkat
71 kg	KOSPAGAROV, Yeldos MAGAMADOV, Ibragim NADYROV, Nurzhan
75 kg	DUMBIROV, Azamat GAJIYEV, Danyal YEREZHEPOV, Maxat
80 kg	DILMUKHAMEDOV, Askhat KERIMBAYEV, Didar KOSHANOV, Zhassulan ZHAKSZYLYKOV, Daulet
85 kg	KUSTUBAYEV, Azamat OZDIEV, Alkhozur TURSNOV, Nursultan
98 kg	ISKAKOV, Yerulan

#### KYRGYZSTAN (KGZ)

##### Lutteur(s) / Wrestler(s) :



## Liste des Engagés par pays / Entry-List By Country

### Hungarian Greco-Roman Golden GP

#### STYLE GR

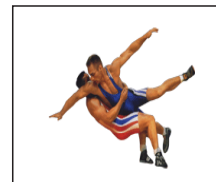

59 kg	ERALIEV, Arsen
66 kg	ASANGULOV, Nurgazy BEGALIEV, Askar
71 kg	TSAREV, Ruslan
75 kg	AZIZBEKOV, Atabek KOBONOV, Daniyar
80 kg	KOBONOV, Daniyar
85 kg	BEISHEBEKOV, Azat KENZHEEV, Zhanarbek
98 kg	MAKHMUDOVS, Beksultan

#### LITHUANIA (LTU)

##### Lutteur(s) / Wrestler(s) :

130 kg	MIZGAITIS, Mindaugas
66 kg	VENCKAITIS, Edgaras
75 kg	VENCKAITIS, Valdemaras

#### MOLDOVA (MDA)

##### Lutteur(s) / Wrestler(s) :

59 kg	CIOBANU, Victor
66 kg	ISLAMOV, Donior MAMULAT, Maxim
75 kg	BESLEAGA, Igor

#### MOROCCO (MAR)

##### Lutteur(s) / Wrestler(s) :

59 kg	FAJARI, Fouad
71 kg	BOUALEM, Aziz
75 kg	AIT OUAGRAM, Zied

#### NORWAY (NOR)

##### Lutteur(s) / Wrestler(s) :

59 kg	BERGE, Stig Andre
66 kg	THOMMESEN, Marius
71 kg	KARLSEN, Petter
85 kg	ISAKSEN, Jon Fredrik



## Liste des Engagés par pays / Entry-List By Country

### Hungarian Greco-Roman Golden GP

STYLE GR

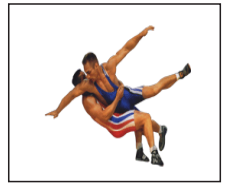

98 kg TJORSTAD, Rasmus  
BALDAUF, Felix  
NIELSEN, Marthin Hamlet

#### POLAND (POL)

##### Lutteur(s) / Wrestler(s) :

59 kg GUCIK, Arkadiusz  
TRACZ, Michal

66 kg BERNATEK, Mateusz  
KARECINSKI, Dawid  
RURKOWSKI, Daniel

75 kg KULYNYCZ, Arkadiusz  
NYLYPIUK, Iwan  
WOLNY, Mateusz

85 kg JANIKOWSKI, Damian  
MICHALIK, Tadeusz

98 kg KROCZAK, Aleksander

#### ROMANIA (ROU)

##### Lutteur(s) / Wrestler(s) :

130 kg BARBAZAN, Tiberiu Alexandru

59 kg MIHUT, Mihairadu

66 kg CARPEN, Georgian

71 kg COJOCARI, Ilie  
HINOVEANU, Tomi Claudiu

75 kg PUSCASU, Ionel

85 kg PIRVAN, Dorin Constantin  
TAMAS, Attila

98 kg ALEXUC, Ciurariu Alin

#### SERBIA (SRB)

##### Lutteur(s) / Wrestler(s) :

130 kg PAVLOVIC, Nemanja

59 kg FRIS, Kristian  
NADJ, Tamas

66 kg MAKSIMOVIC, Aleksandar  
NEMES, Mate

75 kg NEMES, Viktor

80 kg BALO, Petar  
SLEINER, Tamas



## Liste des Engagés par pays / Entry-List By Country

### Hungarian Greco-Roman Golden GP

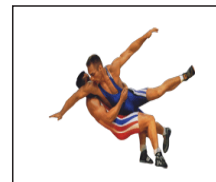

#### STYLE GR

85 kg DEJAN, Frankjkovic  
STANKIC, Vladimir

#### SLOVAKIA (SVK)

**Lutteur(s) / Wrestler(s) :**

75 kg RIGÄĽ, RichÄĽrd

#### SLOVENIA (SLO)

**Lutteur(s) / Wrestler(s) :**

75 kg KUHAR, Jure

#### SWEDEN (SWE)

**Lutteur(s) / Wrestler(s) :**

130 kg EUREN, Johan  
66 kg HARUTYUNYAN, Frunze  
VARDANYAN, Sharur  
71 kg MATHIAS, GÄ¼nther  
NILSSON, Kristoffer  
80 kg JERSGREN, Alexander  
LENNIE, Persson  
85 kg BERG, Zakarias  
JOHANSSON, Kristofer  
PETTERSSON, Jim  
ZAHITI, Fisnik  
98 kg SCHON, Fredrik  
TOUNOUSIDIS, Theodoros

#### SWITZERLAND (SUI)

**Lutteur(s) / Wrestler(s) :**

71 kg CHRISTEN, Nicolas  
75 kg DIETSCHÉ, Damian  
80 kg BOSSERT, Jonas

#### UKRAINE (UKR)

**Lutteur(s) / Wrestler(s) :**

130 kg DIDYK, Igor  
ORLOV, Yevhenii



## Liste des Engagés par pays / Entry-List By Country

### Hungarian Greco-Roman Golden GP

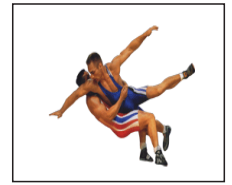

#### STYLE GR

59 kg	MIAGKYI, Ievgen
66 kg	PYSLAR, Dmytro
71 kg	NOVACHOK, Oleksandr
75 kg	DARAGAN, Mykola KUKHTA, Oleksandr PYSHKOV, Ievgen
80 kg	BIELYKH, Andrii CHEKALENKO, Oleksii
85 kg	RACHYBA, Vasyl SHKRIUBA, Iurii SHYSMAN, Oleksandr
98 kg	TIMCHENKO, Dimitriy VASYLIEV, Volodymyr

#### UNITED STATES (USA)

##### Lutteur(s) / Wrestler(s) :

130 kg	SMITH, Robert TRICE, Jarod
59 kg	MANGO, Spencer NICKOLAS, Tiggas SIMPSON, William
66 kg	SADDORIS, Bryce
75 kg	BISEK, Andrew
80 kg	JOSEF, Patrick MARTINEZ, Patrick
85 kg	HOLM, Jordan
98 kg	WILLIAMS, Caylor





Liste des équipes / Teams List

Hungarian Greco-Roman Golden GP

STYLE GR

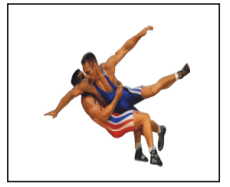

*Equipes - Teams*

	BELARUS	BLR
	CROATIA	CRO
	CZECH REPUBLIC	CZE
	DENMARK	DEN
	EGYPT	EGY
	ESTONIA	EST
	GEORGIA	GEO
	HUNGARY	HUN
	IRAN R.I.	IRI
	ITALY	ITA
	JAPAN	JPN
	KAZAKHSTAN	KAZ
	KYRGYZSTAN	KGZ
	LITHUANIA	LTU
	MOLDOVA	MDA
	MOROCCO	MAR
	NORWAY	NOR
	POLAND	POL
	ROMANIA	ROU
	SERBIA	SRB
	SLOVAKIA	SVK
	SLOVENIA	SLO
	SWEDEN	SWE
	SWITZERLAND	SUI
	UKRAINE	UKR
	UNITED STATES	USA

Nombre d'équipes - Number of Teams

26



**Nombre d'engagés par équipe / Number of Entries By Team**

**Hungarian Greco-Roman Golden GP**

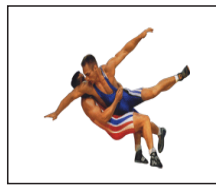

STYLE GR

<i>Equipe - Teams</i>	<b>130 KG</b>	<b>59 KG</b>	<b>66 KG</b>	<b>71 KG</b>	<b>75 KG</b>	<b>80 KG</b>	<b>85 KG</b>	<b>98 KG</b>	<b>TOTAL</b>
BLR	1	2	1		1		1	2	8
CRO			2		1		1		4
CZE					1				1
DEN			2		2				4
EGY		1	1			1	1	1	5
GEO	2	2	1	3	3	1	2	2	16
HUN	1	3	7	3	4	4	2	9	33
IRI				1	1	1	1		4
ITA							1	1	2
JPN		2	3		3	2	1	1	12
KAZ	2	7	7	3	3	4	3	1	30
KGZ			2	1	2	1	2	1	9
LTU			1		1				2
MAR				1	1				2
MDA			2		1				3
NOR			1	1			2	2	6
POL		1	3		3		2	1	10
ROU		1	1	2	1		2	1	8
SRB	1	2	2		1	2	2		10
SUI					1	1			2
SWE	1		2	2		2	4	2	13
UKR	1	1	1	1	3	2	3	2	14
USA	1	3	1		1	2	1	1	10
<b>TOTAL</b>	<b>10</b>	<b>25</b>	<b>40</b>	<b>18</b>	<b>34</b>	<b>23</b>	<b>31</b>	<b>27</b>	<b>208</b>

Nombre de nations - Number of Countries 23





# Feuille de compétition / Competition Sheet

## Hungarian Greco-Roman Golden GP

STYLE : GR 59 kg

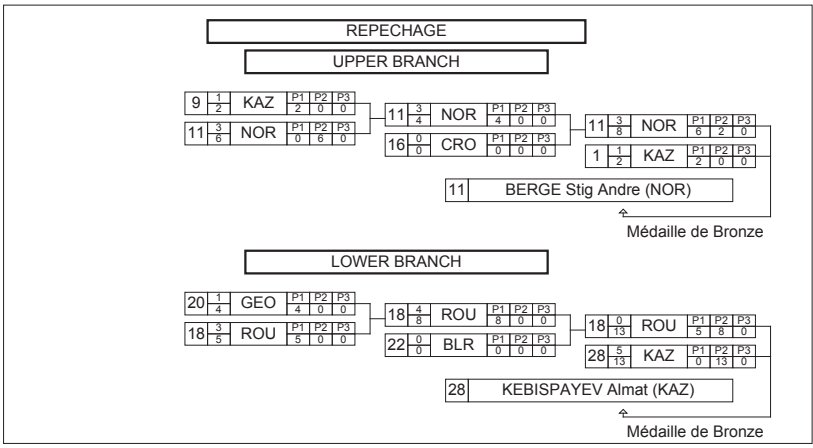
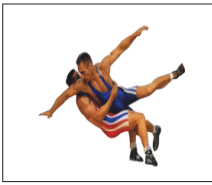



## Classement

### Hungarian Greco-Roman Golden GP

STYLE : GR 59 kg

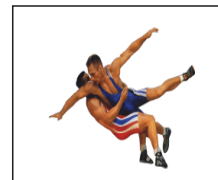

1 - Or / Gold



OTA Shinobu

2 - Argent / Silver



MANGO Spencer

3 - Bronze



BERGE Stig Andre



KEBISPAYEV Almat

Classement	Nom - Name	Pays - Country
1	OTA Shinobu	JPN
2	MANGO Spencer	USA
3	BERGE Stig Andre	NOR
3	KEBISPAYEV Almat	KAZ
5	SARSENBIYEV Z.	KAZ
5	MIHUT Mihairadu	ROU
7	FUMITA Kenichiro	JPN
8	LIZATOVIC Ivan	CRO
9	FRIS Kristian	SRB
10	TAZHIEV Elbek	BLR
11	SIMPSON William	USA
12	DONENBEKOV Meirbek	KAZ
13	HAITHEM MAHMOUD A.	EGY
14	NUGUMANOV Aidyn	KAZ
15	NADJ Tamas	SRB
16	FONNESBEK Tobias	DEN
17	AINAGULOV Mirambek	KAZ
18	DAUROV Soslan	BLR
19	CIOBANU Victor	MDA
20	ERALIEV Arsen	KGZ
21	DAVITADZE Goderzi	GEO
22	HASSAN ABDELAAL MOHAMED M.	EGY
23	MIAGKYI Ievgen	UKR
24	VANADZE Miorza	GEO
25	FAJARI Fouad	MAR
26	MODOS Peter	HUN
27	ZHAKANSNA Khorlan	KAZ
28	KNIPLI Csongor	HUN
29	NICKOLAS Tiggas	USA
29	USKENBEKOV Dastan	KAZ



## Classement

### Hungarian Greco-Roman Golden GP

STYLE : GR 59 kg

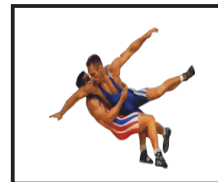

<i>Classement</i>	<i>Nom - Name</i>	<i>Pays - Country</i>
29	KOVACS Bence	HUN
32	TRACZ Michal	POL
33	GUCIK Arkadiusz	POL





# Feuille de compétition / Competition Sheet

## Hungarian Greco-Roman Golden GP

STYLE : GR 66 kg

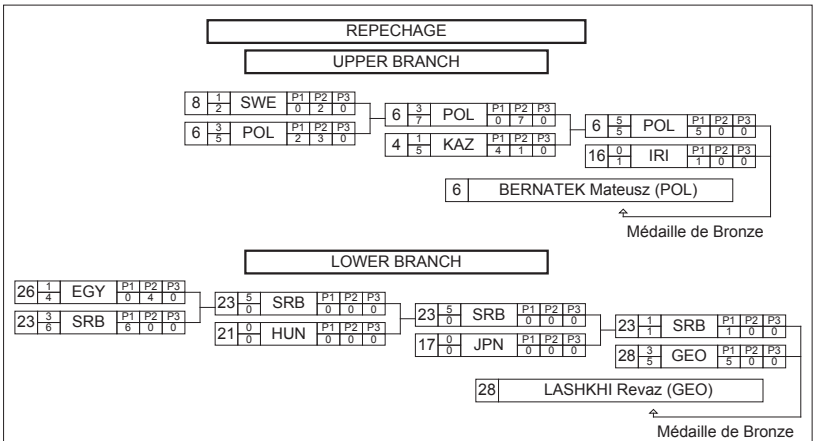
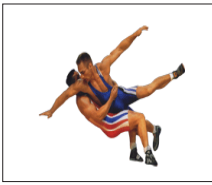





**Classement**

**Hungarian Greco-Roman Golden GP**

STYLE : GR      66 kg

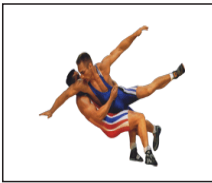

**1 - Or / Gold**



JANECIC Danijel

**2 - Argent / Silver**



ETLINGER Dominik

**3 - Bronze**



BERNATEK Mateusz



LASHKHI Revaz

Classement	Nom - Name	Pays - Country
1	JANECIC Danijel	CRO
2	ETLINGER Dominik	CRO
3	BERNATEK Mateusz	POL
3	LASHKHI Revaz	GEO
5	NEMES Mate	SRB
5	GERAEI Mohammadali	IRI
7	SADDORIS Bryce	USA
8	YENSEKHANOV Aibek	KAZ
9	JAGER Krisztian	HUN
10	LIAKH Pavel	BLR
11	ZHADRAYEV Demeu	KAZ
12	VENCKAITIS Edgaras	LTU
13	NURGALIYEV Nurtai	KAZ
14	MATSUMOTO Ryutaro	JPN
15	BEGALIEV Askar	KGZ
16	MAKSIMOVIC A.	SRB
17	HARUTYUNYAN Frunze	SWE
18	RURKOWSKI Daniel	POL
19	INOUE Tomohiro	JPN
20	FRITSCH Robert	HUN
21	YAMAMOTO Asen	HUN
22	HORIGO Yuta	JPN
23	IBRAHIM MAHMOUD H.	EGY
24	KOZAK Istvan	HUN
25	BJERREHUUS Fredrik	DEN
25	MORBITZER Matous	CZE
27	KARECINSKI Dawid	POL
27	VARDANYAN Sharur	SWE
29	THOMMESEN Marius	NOR
30	CARPEN Georgian	ROU



## Classement

### Hungarian Greco-Roman Golden GP

STYLE : GR 66 kg

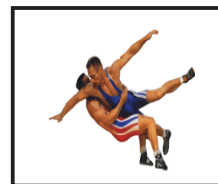

<i>Classement</i>	<i>Nom - Name</i>	<i>Pays - Country</i>
31	NURSAPA Bakbergen	KAZ
32	KAIRATOV Yeldar	KAZ
33	ZHANBIROV Ashkat	KAZ
33	EKSTROEM Anders	DEN
35	LOSONCZI Otto	HUN
35	PYSLAR Dmytro	UKR
35	TOTH Mark	HUN
35	KARIPZHAN Abylai	KAZ
39	SZAKOLCI Zoltan	HUN
40	ASANGULOV Nurgazy	KGZ
41	ISLAMOV Donior	MDA
42	MAMULAT Maxim	MDA



# Feuille de compétition / Competition Sheet

## Hungarian Greco-Roman Golden GP

STYLE : GR 71 kg

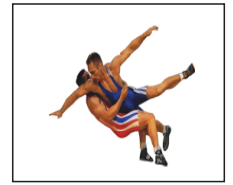

QUALIFICATION		1/8 FINALE		1/4 FINALE		1/2 FINALE		FINALE	
1	NOVACHOK Oleksandr (UKR)	1	4 10	UKR	P1 0	P2 10	P3 0		
2	KOSPAGAROV Yeldos (KAZ)	2	1 1	KAZ	P1 1	P2 0	P3 0		
3	NADYROV Nurzhan (KAZ)	3	3 7	KAZ	P1 7	P2 0	P3 0		
4	MATHIAS GÅ/ntner (SWE)	4	0 0	SWE	P1 0	P2 0	P3 0		
5	COJOCARI Ilie (ROU)	5	4 10	ROU	P1 10	P2 0	P3 0		
6	CHRISTEN Nicolas (SUI)	6	0 0	SUI	P1 0	P2 0	P3 0		
7	MAGAMADOV Ibragim (KAZ)	7	1 8	KAZ	P1 5	P2 1	P3 0		
8	MAMAGEISHVILI A. (GEO)	8	3 10	GEO	P1 2	P2 8	P3 0		
9	KOTTES Pal (HUN)	9	0 0	HUN	P1 0	P2 0	P3 0		
10	TSAREV Ruslan (KGZ)	10	5 8	KGZ	P1 8	P2 0	P3 0		
11	TAHERISARTAND R. (IRI)	11	4 8	IRI	P1 8	P2 0	P3 0		
12	NILSSON Kristoffer (SWE)	12	0 0	SWE	P1 0	P2 0	P3 0		
13	LEVAI Zoltan (HUN)	13	4 15	HUN	P1 7	P2 8	P3 0		
14	HINOVEANU T. (ROU)	14	1 4	ROU	P1 3	P2 1	P3 0		
15	KARLSEN Petter (NOR)	15	1 1	NOR	P1 0	P2 1	P3 0		
16	BOUALEM Aziz (MAR)	16	1 2	MAR	P1 0	P2 2	P3 0		
17	JAVAKHIA Giorgi (GEO)	17	3 5	GEO	P1 4	P2 1	P3 0		
18	KORPASI Balint (HUN)	18	3 6	HUN	P1 2	P2 4	P3 0		
19	TSULUKIDZE Mindia (GEO)	19	0 0	GEO	P1 0	P2 0	P3 0		

18 KORPASI Balint (HUN)

### Classement

Cl	Pays	Nom
1	HUN	KORPASI Balint
2	ROU	COJOCARI Ilie
3	KAZ	NADYROV Nurzhan
3	IRI	TAHERISARTAND Ramin
5	SUI	CHRISTEN Nicolas
5	GEO	TSULUKIDZE Mindia
7	KGZ	TSAREV Ruslan
8	HUN	LEVAI Zoltan
9	UKR	NOVACHOK Oleksandr
10	GEO	JAVAKHIA Giorgi
11	ROU	HINOVEANU T.
12	GEO	MAMAGEISHVILI Anton
13	KAZ	MAGAMADOV Ibragim
14	MAR	BOUALEM Aziz
15	NOR	KARLSEN Petter
16	KAZ	KOSPAGAROV Yeldos
17	SWE	MATHIAS GÅ/ntner
18	HUN	KOTTES Pal
18	SWE	NILSSON Kristoffer

### REPECHAGE

#### REPECHAGE FINALISTE 1

6	5 3	SUI	P1 3	P2 0	P3 0
8	0 2	GEO	P1 2	P2 0	P3 0
3	4 8	KAZ	P1 8	P2 0	P3 0

3 NADYROV Nurzhan (KAZ)

Médaille de Bronze

#### REPECHAGE FINALISTE 2

19	3 2	GEO	P1 2	P2 0	P3 0
17	1 1	GEO	P1 1	P2 0	P3 0
19	4 8	GEO	P1 8	P2 0	P3 0
13	0 0	HUN	P1 0	P2 0	P3 0
19	1 2	GEO	P1 2	P2 0	P3 0
11	3 3	IRI	P1 0	P2 3	P3 0

11 TAHERISARTAND R. (IRI)

Médaille de Bronze



## Classement

### Hungarian Greco-Roman Golden GP

STYLE : GR 71 kg

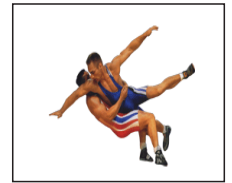

1 - Or / Gold



KORPASI Balint

2 - Argent / Silver



COJOCARI Ilie

3 - Bronze



NADYROV Nurzhan



TAHERISARTAND Ramin

Classement	Nom - Name	Pays - Country
1	KORPASI Balint	HUN
2	COJOCARI Ilie	ROU
3	NADYROV Nurzhan	KAZ
3	TAHERISARTAND Ramin	IRI
5	CHRISTEN Nicolas	SUI
5	TSULUKIDZE Mindia	GEO
7	TSAREV Ruslan	KGZ
8	LEVAI Zoltan	HUN
9	NOVACHOK Oleksandr	UKR
10	JAVAKHIA Giorgi	GEO
11	HINOVEANU T.	ROU
12	MAMAGEISHVILI Anton	GEO
13	MAGAMADOV Ibragim	KAZ
14	BOUALEM Aziz	MAR
15	KARLSEN Petter	NOR
16	KOSPAGAROV Yeldos	KAZ
17	MATHIAS GÅnther	SWE
18	KOTTES Pal	HUN
18	NILSSON Kristoffer	SWE







## Classement

### Hungarian Greco-Roman Golden GP

STYLE : GR 75 kg

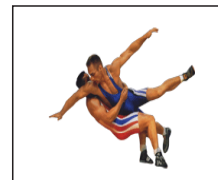

1 - Or / Gold



NEMES Viktor

2 - Argent / Silver



SZABO Laszlo

3 - Bronze



BOUYERI PAYANI Payam



DARAGAN Mykola

Classement	Nom - Name	Pays - Country
1	NEMES Viktor	SRB
2	SZABO Laszlo	HUN
3	BOUYERI PAYANI P.	IRI
3	DARAGAN Mykola	UKR
5	VENCKAITIS V.	LTU
5	TSKHADAIA Manuchar	GEO
7	STARCEVIC Bozo	CRO
8	KULYNYCZ Arkadiusz	POL
9	GULBATASHVILI Ilia	GEO
10	WOLNY Mateusz	POL
11	BACHKO Yauhen	BLR
12	KANAKUBO Takehiro	JPN
13	SZABO Martin	HUN
14	NYLYPIUK Iwan	POL
15	KUHAR Jure	SLO
16	NAGY Peter	HUN
17	MADSEN Mark	DEN
18	AIT OUAGRAM Zied	MAR
19	NOVAK Petr	CZE
20	YABIKU Shohei	JPN
21	PUSCASU Ionel	ROU
22	DUMBIROV Azamat	KAZ
23	KELASOV Nikoloz	GEO
24	ISKANDARANI Ahmed	DEN
24	YEREZHEPOV Maxat	KAZ
26	PYSHKOV Ievgen	UKR
27	MADARASI Gabor	HUN
28	BISEK Andrew	USA
29	KOBONOV Daniyar	KGZ
29	GAJIYEV Danyal	KAZ



## Classement

### Hungarian Greco-Roman Golden GP

STYLE : GR 75 kg

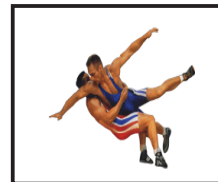

<i>Classement</i>	<i>Nom - Name</i>	<i>Pays - Country</i>
29	BESLEAGA Igor	MDA
29	SAKABE Soh	JPN
33	KUKHTA Oleksandr	UKR
34	AZIZBEKOV Atabek	KGZ
34	RUSSO Ciro	ITA
34	DIETSCHE Damian	SUI
37	RIGÁ³ RichÁjrd	SVK





# Feuille de compétition / Competition Sheet

## Hungarian Greco-Roman Golden GP

STYLE : GR 80 kg

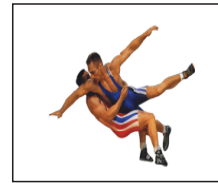

QUALIFICATION			1/8 FINALE			1/4 FINALE			1/2 FINALE			FINALE							
1		BIELYKH Andrii (UKR)				1	5/5	UKR	P1/P2/P3 2/3/0										
2		JERSGREN Alexander (SWE)				2	0/1	SWE	P1/P2/P3 1/0/0										
3		LENNIE Persson (SWE)				3	0/0	SWE	P1/P2/P3 0/0/0										
4		BACSI Peter (HUN)				4	4/8	HUN	P1/P2/P3 8/0/0										
5		DILMUKHAMEDOV A. (KAZ)				5	3/7	KAZ	P1/P2/P3 2/5/0										
6		KOSHANOV Zhassulan (KAZ)				6	0/0	KAZ	P1/P2/P3 0/0/0										
7		BALO Petar (SRB)				7	3/2	SRB	P1/P2/P3 2/0/0										
8		MARTINEZ Patrick (USA)				8	1/2	USA	P1/P2/P3 0/2/0										
9		ZHAKSYLYKOV Daulet (KAZ)				9	1/3	KAZ	P1/P2/P3 3/0/0										
10	4/8	JOSEF Patrick (USA)	P1/P2/P3 8/0/0			10	4/11	USA	P1/P2/P3 11/0/0										
11	0/0	SLEINER Tamas (SRB)	P1/P2/P3 0/0/0			13	0/0	HUN	P1/P2/P3 0/0/0										
12	1/4	KERIMBAYEV Didar (KAZ)	P1/P2/P3 0/4/0			15	4/8	SUI	P1/P2/P3 8/0/0										
13	4/12	SZILVASSY Erik (HUN)	P1/P2/P3 4/8/0			17	5/3	GEO	P1/P2/P3 1/2/0										
14	1/2	KOBONOV Daniyar (KGZ)	P1/P2/P3 0/2/0			17	5/3	GEO	P1/P2/P3 0/3/0										
15	3/8	BOSSERT Jonas (SUI)	P1/P2/P3 8/0/0			18	0/2	IRI	P1/P2/P3 2/0/0										
16	1/1	UBRANKOVICS N. (HUN)	P1/P2/P3 1/0/0			20	0/0	JPN	P1/P2/P3 0/0/0										
17	4/9	TSIREKIDZE Giorgi (GEO)	P1/P2/P3 9/0/0			23	0/3	EGY	P1/P2/P3 2/1/0										
18	3/4	ZINATIREFAH Ali (IRI)	P1/P2/P3 0/4/0																
19	1/2	DR. KUN R. Zsolt (HUN)	P1/P2/P3 2/0/0																
20	4/8	SUMI Masato (JPN)	P1/P2/P3 7/1/0																
21	0/0	MAETA Yuya (JPN)	P1/P2/P3 0/0/0																
22	0/0	CHEKALENKO Oleksii (UKR)	P1/P2/P3 0/0/0																
23	4/9	TAREK MOHAMED A. (EGY)	P1/P2/P3 6/3/0																

4 BACSI Peter (HUN)

### Classement

Cl	Pays	Nom
1	HUN	BACSI Peter
2	GEO	TSIREKIDZE Giorgi
3	UKR	BIELYKH Andrii
3	USA	JOSEF Patrick
5	KAZ	DILMUKHAMEDOV A.
5	IRI	ZINATIREFAH Ali
7	EGY	TAREK MOHAMED A.
8	SUI	BOSSERT Jonas
9	JPN	SUMI Masato
10	HUN	SZILVASSY Erik
11	SRB	BALO Petar
12	KAZ	KERIMBAYEV Didar
13	KAZ	ZHAKSYLYKOV Daulet
14	USA	MARTINEZ Patrick
15	HUN	DR. KUN R. Zsolt
16	KGZ	KOBONOV Daniyar
17	HUN	UBRANKOVICS Norbert
18	SWE	JERSGREN Alexander
19	KAZ	KOSHANOV Zhassulan
20	SRB	SLEINER Tamas
20	JPN	MAETA Yuya
22	UKR	CHEKALENKO Oleksii
23	SWE	LENNIE Persson

### REPECHAGE

#### REPECHAGE FINALISTE 1

3	0/0	SWE	P1/P2/P3 0/0/0	1	3/2	UKR	P1/P2/P3 2/0/0	5	0/0	KAZ	P1/P2/P3 0/0/0
1	4/8	UKR	P1/P2/P3 8/0/0								
<b>1 BIELYKH Andrii (UKR)</b>											

Médaille de Bronze

#### REPECHAGE FINALISTE 2

16	0/0	HUN	P1/P2/P3 0/0/0	18	3/3	IRI	P1/P2/P3 3/0/0	18	1/2	IRI	P1/P2/P3 2/0/0
18	3/5	IRI	P1/P2/P3 5/0/0	23	1/2	EGY	P1/P2/P3 2/0/0	10	4/10	USA	P1/P2/P3 6/4/0
<b>10 JOSEF Patrick (USA)</b>											

Médaille de Bronze



## Classement

### Hungarian Greco-Roman Golden GP

STYLE : GR 80 kg

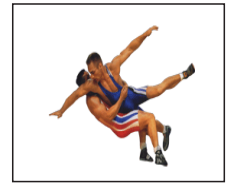

1 - Or / Gold



BACSI Peter

2 - Argent / Silver



TSIREKIDZE Giorgi

3 - Bronze



BIELYKH Andrii



JOSEF Patrick

Classement	Nom - Name	Pays - Country
1	BACSI Peter	HUN
2	TSIREKIDZE Giorgi	GEO
3	BIELYKH Andrii	UKR
3	JOSEF Patrick	USA
5	ZINATIREFAH Ali	IRI
5	DILMUKHAMEDOV A.	KAZ
7	TAREK MOHAMED A.	EGY
8	BOSSERT Jonas	SUI
9	SUMI Masato	JPN
10	SZILVASSY Erik	HUN
11	BALO Petar	SRB
12	KERIMBAYEV Didar	KAZ
13	ZHAKSYLYKOV Daulet	KAZ
14	MARTINEZ Patrick	USA
15	DR. KUN R. Zsolt	HUN
16	KOBONOV Daniyar	KGZ
17	UBRANKOVICS Norbert	HUN
18	JERSGREN Alexander	SWE
19	KOSHANOV Zhassulan	KAZ
20	SLEINER Tamas	SRB
20	MAETA Yuya	JPN
22	CHEKALENKO Oleksii	UKR
23	LENNIE Persson	SWE



# Feuille de compétition / Competition Sheet

## Hungarian Greco-Roman Golden GP

STYLE : GR 85 kg



QUALIFICATION				1/8 FINALE		1/4 FINALE		1/2 FINALE		FINALE	
1		SHKRIUBA Iurii (UKR)		1	0	UKR	P1	P2	P3		
					0		0	0	0		
2	3	KUSTUBAYEV Azamat (KAZ)	P1	2	4	KAZ	P1	P2	P3		
	7		7	0	8		2	1	0		
3	1	DEJAN Frankjkovic (SRB)	P1	2	2	IRI	P1	P2	P3		
	3		0	3	0		1	2	0		
4	0	PIRVAN D. (ROU)	P1	5	1	GEO	P1	P2	P3		
			0	0	2		0	2	0		
5	3	SOPADZE Mate (GEO)	P1	7	3	SWE	P1	P2	P3		
	3		2	1	0		0	3	0		
6	0	BEISHEBEKOV Azat (KGZ)	P1	7	2	SWE	P1	P2	P3		
	0		0	0	0		0	2	0		
7	3	JOHANSSON K. (SWE)	P1	9	1	IRI	P1	P2	P3		
	3		0	3	0		1	2	0		
8	0	SZABO Patrik (HUN)	P1	11	3	BLR	P1	P2	P3		
	0		0	0	0		3	1	0		
9	3	KARIMFAR Mojtaba (IRI)	P1	11	4	BLR	P1	P2	P3		
	4		2	2	0		0	2	0		
10	1	ZAHITI Fisnik (SWE)	P1	12	3	KAZ	P1	P2	P3		
	1		1	0	0		0	1	0		
11	3	KIKINIOU A. (BLR)	P1	12	1	KAZ	P1	P2	P3		
	2		0	2	0		0	2	0		
12	3	TURSYNOV Nursultan (KAZ)	P1	14	0	UKR	P1	P2	P3		
	4		4	0	0		0	0	0		
13	1	GEGESHIDZE V. (GEO)	P1	17	5	POL	P1	P2	P3		
	4		2	2	0		6	0	0		
14	3	SHYSMAN Oleksandr (UKR)	P1	18	0	NOR	P1	P2	P3		
	7		6	1	0		0	0	0		
15	1	AHMED MOHAMED I. (EGY)	P1	20	3	NOR	P1	P2	P3		
	2		0	2	0		0	1	0		
16	0	JANIKOWSKI Damian (POL)	P1	20	1	NOR	P1	P2	P3		
	0		0	0	0		0	1	0		
17	5	MICHALIK Tadeusz (POL)	P1	22	1	SWE	P1	P2	P3		
	8		2	6	0		0	1	0		
18	3	ISAKSEN J. (NOR)	P1	22	1	SWE	P1	P2	P3		
	4		1	3	0		0	1	0		
19	1	PARISI Fabio (ITA)	P1	24	4	USA	P1	P2	P3		
	1		0	1	0		2	6	0		
20	4	TJORSTAD Rasmus (NOR)	P1	24	3	USA	P1	P2	P3		
	8		8	0	0		0	5	0		
21	0	BALOGH Laszlo (HUN)	P1	26	0	UKR	P1	P2	P3		
	0		0	0	0		0	0	0		
22	4	BERG Zakarias (SWE)	P1	28	5	KAZ	P1	P2	P3		
	8		2	6	0		4	0	0		
23	0	ZUGAJ Nenad (CRO)	P1	28	0	KAZ	P1	P2	P3		
	0		0	0	0		0	0	0		
24	3	HOLM Jordan (USA)	P1	31	0	SWE	P1	P2	P3		
	5		5	0	0		0	0	0		
25	1	KENZHEEV Zhanarbek (KGZ)	P1								
	4		4	0	0						
26	3	RACHYBA Vasyl (UKR)	P1								
	6		2	4	0						
27	0	OKA Taichi (JPN)	P1								
	0		0	0	0						
28	4	OZDIEV Alkhozur (KAZ)	P1								
	11		11	0	0						
29	1	STANKIC Vladimir (SRB)	P1								
	2		2	0	0						
30	1	TAMAS Attila (ROU)	P1								
	1		0	1	0						
31	3	PETTERSSON Jim (SWE)	P1								
	4		0	4	0						

24 HOLM Jordan (USA)

### Classement

Cl	Pays	Nom
1	USA	HOLM Jordan
2	SWE	JOHANSSON Kristofer
3	GEO	SOPADZE Mate
3	UKR	RACHYBA Vasyl
5	KAZ	TURSYNOV Nursultan
5	NOR	TJORSTAD Rasmus
7	POL	MICHALIK Tadeusz
8	KAZ	OZDIEV Alkhozur
9	KAZ	KUSTUBAYEV Azamat
10	BLR	KIKINIOU Aliaksandr
11	SWE	BERG Zakarias
12	IRI	KARIMFAR Mojtaba
13	UKR	SHYSMAN Oleksandr
14	SWE	PETTERSSON Jim
15	NOR	ISAKSEN Jon Fredrik
16	GEO	GEGESHIDZE Vladimir
17	KGZ	KENZHEEV Zhanarbek
18	SRB	DEJAN Frankjkovic
19	EGY	AHMED MOHAMED I.
20	SRB	STANKIC Vladimir
21	SWE	ZAHITI Fisnik
22	ROU	TAMAS Attila
22	ITA	PARISI Fabio
24	ROU	PIRVAN D.
25	HUN	SZABO Patrik
26	JPN	OKA Taichi
27	UKR	SHKRIUBA Iurii
27	POL	JANIKOWSKI Damian
27	HUN	BALOGH Laszlo
27	CRO	ZUGAJ Nenad
31	KGZ	BEISHEBEKOV Azat

### REPECHAGE

#### REPECHAGE FINALISTE 1

6	0	KGZ	P1	P2	P3	5	3	GEO	P1	P2	P3	5	3	GEO	P1	P2	P3
	0		0	0	0	5	3		1	2	0	5	3		1	3	0
5	4	GEO	P1	P2	P3	2	0	KAZ	P1	P2	P3	12	1	KAZ	P1	P2	P3
	8		8	0	0	0	0		0	0	0	0	2		0	2	0

5 SOPADZE Mate (GEO)

Médaille de Bronze

#### REPECHAGE FINALISTE 2

25	0	KGZ	P1	P2	P3	26	5	UKR	P1	P2	P3	26	3	UKR	P1	P2	P3
	0		0	0	0	26	4		4	0	0	26	2		2	0	0
26	3	UKR	P1	P2	P3	28	0	KAZ	P1	P2	P3	20	0	NOR	P1	P2	P3
	3		2	1	0	1	0		1	0	0	0	0		0	0	0

26 RACHYBA Vasyl (UKR)

Médaille de Bronze

# Classement

## Hungarian Greco-Roman Golden GP

STYLE : GR 85 kg

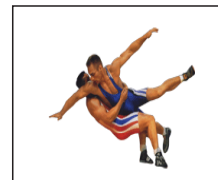

1 - Or / Gold



HOLM Jordan

2 - Argent / Silver



JOHANSSON Kristofer

3 - Bronze



SOPADZE Mate



RACHYBA Vasyl

Classement	Nom - Name	Pays - Country
1	HOLM Jordan	USA
2	JOHANSSON Kristofer	SWE
3	SOPADZE Mate	GEO
3	RACHYBA Vasyl	UKR
5	TURSYNOV Nursultan	KAZ
5	TJORSTAD Rasmus	NOR
7	MICHALIK Tadeusz	POL
8	OZDIEV Alkhozur	KAZ
9	KUSTUBAYEV Azamat	KAZ
10	KIKINIOU Aliaksandr	BLR
11	BERG Zakarias	SWE
12	KARIMFAR Mojtaba	IRI
13	SHYSMAN Oleksandr	UKR
14	PETTERSSON Jim	SWE
15	ISAKSEN Jon Fredrik	NOR
16	GEGESHIDZE Vladimer	GEO
17	KENZHEEV Zhanarbek	KGZ
18	DEJAN Frankjkovic	SRB
19	AHMED MOHAMED I.	EGY
20	STANKIC Vladimir	SRB
21	ZAHITI Fisnik	SWE
22	TAMAS Attila	ROU
22	PARISI Fabio	ITA
24	PIRVAN D.	ROU
25	SZABO Patrik	HUN
26	OKA Taichi	JPN
27	SHKRIUBA Iurii	UKR
27	JANIKOWSKI Damian	POL
27	BALOGH Laszlo	HUN
27	ZUGAJ Nenad	CRO



## Classement

### Hungarian Greco-Roman Golden GP

STYLE : GR 85 kg

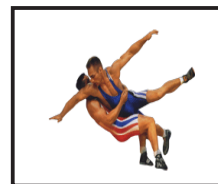

<i>Classement</i>	<i>Nom - Name</i>	<i>Pays - Country</i>
31	BEISHEBEKOV Azat	KGZ



# Feuille de compétition / Competition Sheet

## Hungarian Greco-Roman Golden GP

STYLE : GR 98 kg



QUALIFICATION				1/8 FINALE			1/4 FINALE			1/2 FINALE			FINALE				
1		KISS Balazs (HUN)		1	4	HUN	P1	P2	P3	1	3	HUN	P1	P2	P3		
					9		9	0	0		1	1	0	1	0		
2		MAKHMUDOV B. (KGZ)		2	0	KGZ	P1	P2	P3	4	0	HUN	P1	P2	P3		
					0		0	0	0		0	0	0	0	0		
3		STARADUB Siarhei (BLR)		3	0	BLR	P1	P2	P3	7	3	ROU	P1	P2	P3		
					0		0	0	0		1		0	1	0		
4		NEMETH Ivan (HUN)		4	4	HUN	P1	P2	P3	10	1	HUN	P1	P2	P3		
					8		5	3	0		2		0	2	0		
5		NIELSEN M. (NOR)		5	1	NOR	P1	P2	P3	13	3	ITA	P1	P2	P3		
					1		0	1	0		2		2	0	0		
6	0	OSAKA Akira (JPN)	P1	P2	P3	7	3	ROU	P1	P2	P3	7	1	ROU	P1	P2	P3
	0		0	0	0		1		0		1		1	0	0		
7	3	ALEXUC C. (ROU)	P1	P2	P3	9	1	SWE	P1	P2	P3	10	1	HUN	P1	P2	P3
	5		2	3	0		1		0		2		0	2	0		
8	1	KROCZAK Aleksander (POL)	P1	P2	P3	10	3	HUN	P1	P2	P3	13	3	ITA	P1	P2	P3
	2		2	0	0		3		0		2		2	0	0		
9	3	SCHON Fredrik (SWE)	P1	P2	P3	11	1	VASYLIEV Volodymyr (UKR)	P1	P2	P3	13	2	ITA	P1	P2	P3
	4		0	4	0		1		0		3		0	0	0		
10	3	MAJOROS A. (HUN)	P1	P2	P3	12	1	ISKAKOV Yerulan (KAZ)	P1	P2	P3	15	0	HUN	P1	P2	P3
	2		2	0	0		4		0		0		0	0	0		
11	1	VASYLIEV Volodymyr (UKR)	P1	P2	P3	13	3	ITA	P1	P2	P3	17	1	HUN	P1	P2	P3
	1		0	1	0		7		4		3		1	0	0		
12	1	ISKAKOV Yerulan (KAZ)	P1	P2	P3	14	1	WILLIAMS Caylor (USA)	P1	P2	P3	19	1	BLR	P1	P2	P3
	4		4	0	0		3		3		1		0	1	0		
13	3	TIMONCINI Daigoro (ITA)	P1	P2	P3	15	0	ALMASI Ferenc (HUN)	P1	P2	P3	19	3	BLR	P1	P2	P3
	5		4	1	0		0		7		4		0	0	0		
14	1	WILLIAMS Caylor (USA)	P1	P2	P3	16	0	BALDAUF Felix (NOR)	P1	P2	P3	20	3	TOUNOUSIDIS T. (SWE)	P1	P2	P3
	3		3	0	0		0		0		1		0	1	0		
15	4	ALMASI Ferenc (HUN)	P1	P2	P3	17	1	VARGA Adam (HUN)	P1	P2	P3	21	0	MERTSE Adam (HUN)	P1	P2	P3
	11		7	4	0		1		1		0		0	0	0		
16	0	BALDAUF Felix (NOR)	P1	P2	P3	19	3	DZEINICHENKA T. (BLR)	P1	P2	P3	22	3	TOROK Zsolt (HUN)	P1	P2	P3
	0		0	0	0		3		0		0		3	0	0		
17	3	VARGA Adam (HUN)	P1	P2	P3	20	1	SWE	P1	P2	P3	22	3	HUN	P1	P2	P3
	1		0	1	0		1		1		0		0	2	0		
18	0	FODOR Peter (HUN)	P1	P2	P3	24	3	GEO	P1	P2	P3	24	0	GEO	P1	P2	P3
	0		0	0	0		3		0		3		0	3	0		
19	3	DZEINICHENKA T. (BLR)	P1	P2	P3	26	0	ABDELLATIF MOHAMED A. (EGY)	P1	P2	P3	27	1	UKR	P1	P2	P3
	6		6	0	0		0		0		1		0	0	0		
20	3	TOUNOUSIDIS T. (SWE)	P1	P2	P3	27	5	TIMCHENKO Dimitriy (UKR)	P1	P2	P3						
	1		0	1	0		4		0		0		0	0	0		
21	0	MERTSE Adam (HUN)	P1	P2	P3												
	0		0	0	0												
22	3	TOROK Zsolt (HUN)	P1	P2	P3												
	3		0	3	0												
23	0	FODOR Tamas (HUN)	P1	P2	P3												
	0		0	0	0												
24	3	IMERLISHVILI Vasil (GEO)	P1	P2	P3												
	1		1	0	0												
25	0	JABIDZE Soso (GEO)	P1	P2	P3												
	0		0	0	0												
26	0	ABDELLATIF MOHAMED A. (EGY)	P1	P2	P3												
	0		0	0	0												
27	5	TIMCHENKO Dimitriy (UKR)	P1	P2	P3												
	4		4	0	0												

1 KISS Balazs (HUN)

### Classement

Cl	Pays	Nom
1	HUN	KISS Balazs
2	ITA	TIMONCINI Daigoro
3	ROU	ALEXUC C.
3	BLR	DZEINICHENKA T.
5	HUN	NEMETH Ivan
5	HUN	TOROK Zsolt
7	HUN	MAJOROS Armin Mozes
8	GEO	IMERLISHVILI Vasil
9	UKR	TIMCHENKO Dimitriy
10	HUN	ALMASI Ferenc
11	KAZ	ISKAKOV Yerulan
12	SWE	SCHON Fredrik
13	SWE	TOUNOUSIDIS T.
14	HUN	VARGA Adam
15	USA	WILLIAMS Caylor
16	POL	KROCZAK Aleksander
17	NOR	NIELSEN M.
18	UKR	VASYLIEV Volodymyr
19	GEO	JABIDZE Soso
19	HUN	MERTSE Adam
19	NOR	BALDAUF Felix
22	HUN	FODOR Tamas
23	EGY	ABDELLATIF MOHAMED A.
24	JPN	OSAKA Akira
25	HUN	FODOR Peter
26	BLR	STARADUB Siarhei
27	KGZ	MAKHMUDOV Beksultan

### REPECHAGE

REPECHAGE FINALISTE 1					
2	0	KGZ	P1	P2	P3
	0		0	0	0
4	5	HUN	P1	P2	P3
	4		4	0	0
7 ALEXUC C. (ROU)					

Médaille de Bronze

REPECHAGE FINALISTE 2					
12	3	KAZ	P1	P2	P3
	7		2	5	0
15	1	HUN	P1	P2	P3
	2		2	0	0
12	1	KAZ	P1	P2	P3
	5		4	1	0
19	3	BLR	P1	P2	P3
	6		2	4	0
19	0	HUN	P1	P2	P3
	0		0	0	0
19 DZEINICHENKA T. (BLR)					

Médaille de Bronze

## Classement

### Hungarian Greco-Roman Golden GP

STYLE : GR      98 kg

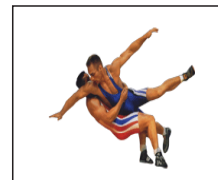

**1 - Or / Gold**



KISS Balazs

**2 - Argent / Silver**



TIMONCINI Daigoro

**3 - Bronze**



ALEXUC Ciurariu Alin



DZEINICHENKA Tsimafei

Classement	Nom - Name	Pays - Country
1	KISS Balazs	HUN
2	TIMONCINI Daigoro	ITA
3	ALEXUC C.	ROU
3	DZEINICHENKA T.	BLR
5	NEMETH Ivan	HUN
5	TOROK Zsolt	HUN
7	MAJOROS Armin Mozes	HUN
8	IMERLISHVILI Vasil	GEO
9	TIMCHENKO Dimitriy	UKR
10	ALMASI Ferenc	HUN
11	ISKAKOV Yerulan	KAZ
12	SCHON Fredrik	SWE
13	TOUNOUSIDIS T.	SWE
14	VARGA Adam	HUN
15	WILLIAMS Caylor	USA
16	KROCZAK Aleksander	POL
17	NIELSEN M.	NOR
18	VASYLIEV Volodymyr	UKR
19	BALDAUF Felix	NOR
19	MERTSE Adam	HUN
19	JABIDZE Soso	GEO
22	FODOR Tamas	HUN
23	ABDELLATIF MOHAMED A.	EGY
24	OSAKA Akira	JPN
25	FODOR Peter	HUN
26	STARADUB Siarhei	BLR
27	MAKHMUDOV Beksultan	KGZ



# Feuille de compétition / Competition Sheet

## Hungarian Greco-Roman Golden GP

STYLE : GR 130 kg



QUALIFICATION				1/8 FINALE				1/4 FINALE				1/2 FINALE				FINALE																															
1		MIZGAITIS M. (LTU)						1	3	1	LTU	P1	P2	P3				1	5	4	LTU	P1	P2	P3				1	0	2	LTU	P1	P2	P3				8	0	0	HUN	P1	P2	P3			
2		SMITH Robert (USA)						2	0	0	USA	P1	P2	P3				3	0	0	KAZ	P1	P2	P3				8	5	2	HUN	P1	P2	P3													
3		KUZEMBAYEV Damir (KAZ)						3	4	8	KAZ	P1	P2	P3				5	0	0	SRB	P1	P2	P3				8	3	2	HUN	P1	P2	P3													
4		GOGISVANIDZE Shota (GEO)						4	0	0	GEO	P1	P2	P3				7	1	1	BLR	P1	P2	P3				9	4	8	HUN	P1	P2	P3													
5		PAVLOVIC Nemanja (SRB)						5	3	3	SRB	P1	P2	P3				8	3	1	HUN	P1	P2	P3				9	3	5	HUN	P1	P2	P3													
6		SARTBAYEV A. (KAZ)						6	1	1	KAZ	P1	P2	P3				11	0	3	UKR	P1	P2	P3				12	0	0	JPN	P1	P2	P3													
7		HRYSHCHANKA Kiryl (BLR)						7	1	1	BLR	P1	P2	P3				12	5	6	JPN	P1	P2	P3				14	3	1	EST	P1	P2	P3													
8		LAM Balint (HUN)						8	3	1	HUN	P1	P2	P3				13	0	0	SWE	P1	P2	P3				14	0	0	EST	P1	P2	P3													
9		LIGETI Daniel (HUN)						9	3	5	HUN	P1	P2	P3				15	3	3	KAZ	P1	P2	P3				15	0	0	KAZ	P1	P2	P3													
10		BARBAZAN T. (ROU)						10	1	2	ROU	P1	P2	P3				16	0	0	USA	P1	P2	P3				17	1	2	UKR	P1	P2	P3													
11		DIDYK Igor (UKR)						11	0	3	UKR	P1	P2	P3				17	3	3	GEO	P1	P2	P3				18	3	3	GEO	P1	P2	P3													
12		SONODA Arata (JPN)						12	5	6	JPN	P1	P2	P3																																	
13		EUREN Johan (SWE)						13	0	0	SWE	P1	P2	P3																																	
14		NABI Heiki (EST)						14	3	2	EST	P1	P2	P3																																	
15	4	TINALIYEV N. (KAZ)	P1	P2	P3			15	3	3	KAZ	P1	P2	P3																																	
16	0	TRICE Jarod (USA)	P1	P2	P3			16	0	0	USA	P1	P2	P3																																	
17	1	ORLOV Yevhenii (UKR)	P1	P2	P3			17	1	2	UKR	P1	P2	P3																																	
18	3	KAJAIA Iakob (GEO)	P1	P2	P3			18	3	2	GEO	P1	P2	P3																																	

9 LIGETI Daniel (HUN)

### Classement

Cl	Pays	Nom
1	HUN	LIGETI Daniel
2	HUN	LAM Balint
3	BLR	HRYSHCHANKA Kiryl
3	EST	NABI Heiki
5	LTU	MIZGAITIS Mindaugas
5	ROU	BARBAZAN T.
7	KAZ	TINALIYEV Nurmakhan
8	JPN	SONODA Arata
9	KAZ	KUZEMBAYEV Damir
10	GEO	KAJAIA Iakob
11	SRB	PAVLOVIC Nemanja
12	UKR	ORLOV Yevhenii
13	KAZ	SARTBAYEV Abdumalik
14	UKR	DIDYK Igor
15	USA	SMITH Robert
16	SWE	EUREN Johan
17	USA	TRICE Jarod
17	GEO	GOGISVANIDZE Shota

### REPECHAGE

#### REPECHAGE FINALISTE 1

7	3	7	BLR	P1	P2	P3				7	3	2	BLR	P1	P2	P3			
5	1	1	SRB	P1	P2	P3				1	0	0	LTU	P1	P2	P3			

7 HRYSHCHANKA Kiryl (BLR)

Médaille de Bronze

#### REPECHAGE FINALISTE 2

10	5	4	ROU	P1	P2	P3				10	0	0	ROU	P1	P2	P3			
12	0	2	JPN	P1	P2	P3				14	4	9	EST	P1	P2	P3			

14 NABI Heiki (EST)

Médaille de Bronze



**Classement****Hungarian Greco-Roman Golden GP**

STYLE : GR 130 kg

UNITED WORLD  
WRESTLING**1 - Or / Gold**

LIGETI Daniel

**2 - Argent / Silver**

LAM Balint

**3 - Bronze**

HRYSHCHANKA Kiryl



NABI Heiki

<i>Classement</i>	<i>Nom - Name</i>	<i>Pays - Country</i>
1	LIGETI Daniel	HUN
2	LAM Balint	HUN
3	HRYSHCHANKA Kiryl	BLR
3	NABI Heiki	EST
5	MIZGAITIS Mindaugas	LTU
5	BARBAZAN T.	ROU
7	TINALIYEV Nurmakhan	KAZ
8	SONODA Arata	JPN
9	KUZEMBAYEV Damir	KAZ
10	KAJAIA Iakob	GEO
11	PAVLOVIC Nemanja	SRB
12	ORLOV Yevhenii	UKR
13	SARTBAYEV Abdumalik	KAZ
14	DIDYK Igor	UKR
15	SMITH Robert	USA
16	EUREN Johan	SWE
17	TRICE Jarod	USA
17	GOGISVANIDZE Shota	GEO



**Classement par équipe / Teams ranking**

**Hungarian Greco-Roman Golden GP**

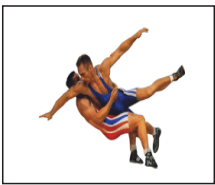

STYLE GR

Rang	Equipe	130 KG	59 KG	66 KG	71 KG	75 KG	80 KG	85 KG	98 KG	TOTAL
1	HUN	19		2	13	9	11		27	81
2	KAZ	6	14	3	8		6	11		48
3	GEO	1		8	7	8	9	8	3	44
4	USA		9	4			8	10		31
5	ROU	6	6		9				8	29
6	UKR				2	8	8	8	2	28
7	IRI			6	8	8	6			28
8	CRO		3	19		4				26
9	JPN	3	14				2			19
10	BLR	8	1	1				1	8	19
11	SRB		2	6		10				18
12	POL			8		4		4		16
13	NOR		8					6		14
14	LTU	6				6				12
15	ITA								9	9
16	SWE							9		9
17	SUI				6		3			9
18	EST	8								8
19	EGY						4			4
20	KGZ				4					4
21	CZE									0
21	DEN									0
21	MAR									0
21	MDA									0
21	SLO									0
21	SVK									0